



M3

We are pleased you have decided on a BMW M3.

Thorough familiarity with your vehicle will provide you with enhanced control and security when you drive it. We therefore have this request:

Please take the time to read this Owner's Manual and familiarize yourself with the information that we have compiled for you before starting off in your new BMW M3. The manual contains important data and instructions intended to assist you in obtaining maximum satisfaction from your BMW M3 unique array of advanced technical features. In addition, you will receive information on vehicle maintenance, that help ensure operating and traffic safety, as well providing for the best possible value retention of your BMW.

For more detailed information refer to the Supplemental Manuals.

BMW M also makes decisive contribution toward greater safety in traffic through its BMW driver training.

This Owner's Manual should be considered a permanent part of this vehicle. It should stay with the vehicle when sold to provide the next owner with important operating, safety and maintenance information.

This manual is supplemented by a Service and Warranty Information Booklet (US models) or a Warranty and Service Guide Booklet (Canadian models). We recommend that you read this publication thoroughly.

Your BMW M3 is covered by the following warranties:

- New Vehicle Limited Warranty
- Limited Rust Perforation Warranty
- Federal Emissions System Defect Warranty
- Federal Emissions Performance Warranty
- California Emission Control System Limited Warranty

Detailed information about these warranties is listed in the Service and Warranty Information Booklet (US models) or in the Warranty and Service Guide Booklet (Canadian models).

We wish you an enjoyable driving experience.

BMW M

Contents

Overview

- Cockpit 14
- Instrument cluster 15
- Indicator and warning lamps 17
- Steering wheel with multifunction buttons 21
- Warning triangle 22
- First-aid kit 22
- Refueling 22
- Fuel specifications 24
- Tire inflation pressures 24

Controls and features

- Opening and closing:**
- Keys 28
- Central locking system 28
- Opening and closing – via the door lock 29
- Opening and closing – via the remote control 30
- Opening and closing – from the inside 33
- Luggage compartment lid 34
- Luggage compartment 36
- Alarm system 37
- Electric power windows 39
- Sliding/tilt sunroof 40

Adjustments:

- Correct sitting position 42
- Seats 43
- Head restraints 44
- Entering the rear 45
- Safety belts 45
- Seat and mirror memory 46
- Seat heating 47
- Steering wheel 47
- Mirrors 48

Passenger safety systems:

- Airbags 49
- Transporting children safely 52
- Vehicle Memory, Key Memory 55

Driving:

- Ignition lock 56
- Starting the engine 56
- Switching off the engine 57
- Parking brake 58
- Manual transmission 58
- Sequential M gearbox SMG II 59
- Indicator/Headlamp flasher 65
- Washer/Wiper system/Rain sensor 66
- Cruise control 68

Everything under control:

- Odometer 70
- Tachometer 70
- Temperature gauge 70
- Fuel gauge 71
- Temperature gauge 71
- Service Interval Display 71
- Check Control 72
- Computer 72

Technology for driving comfort and safety:

- Park Distance Control (PDC) 75
- Dynamic Stability Control (DSC) 76
- Flat Tire Monitor 77
- M Engine dynamics control 79

- Controls and features**
- Lamps:**
 - Parking lamps/Low beams 80
 - Instrument lighting 81
 - High beams/Standing lamps 81
 - Fog lamps 82
 - Interior lamps 82
 - Reading lamps 82
 - Controlling the climate for pleasant driving:**
 - Air conditioner 83
 - Automatic climate control 86
 - Roller sun blind 89
 - Interior conveniences:**
 - Sound system 90
 - Glove compartment 90
 - Storage compartments 91
 - Cellular phone 92
 - Ashtray, front 92
 - Ashtray, rear 93
 - Clothes hooks 93
 - Loading and transporting:**
 - Through-loading system 94
 - Ski bag 95
 - Cargo loading 96
 - Roof-mounted luggage rack 97
- Operation, maintenance**
- Special operating instructions:**
 - Break-in procedure 100
 - Driving notes 101
 - Antilock Brake System 101
 - Brake system 102
 - Wheels and tires:**
 - Tire inflation pressure 103
 - Tire condition 103
 - Tire replacement 104
 - Wheel and tire combinations 105
 - Special characteristics of winter tires 106
 - Snow chains 106
 - In the engine compartment:**
 - Hood 107
 - Engine compartment essentials 108
 - Washer fluids 109
 - Engine oil 110
 - Coolant 112
 - Brake fluid 113
 - Maintenance:**
 - The BMW Maintenance System 114
 - Laws and regulations:**
 - Technical modifications 115
 - California Proposition 65 Warning 115
 - OBD interface socket 116

Contents

Owner service procedures

Replacement procedures:

- Onboard tool kit [120](#)
- Windshield wiper blades [120](#)
- Lamps and bulbs [120](#)
- Repairing a flat tire [126](#)
- Battery [130](#)
- Fuses [130](#)

Giving and receiving assistance:

- Jump-starting [131](#)
- Towing the vehicle [132](#)

Technical data

- Engine data [136](#)
- Dimensions [137](#)
- Weights [138](#)
- Capacities [139](#)

Index

- Everything from A to Z [142](#)

Notes on the Owner's Manual

We have made every effort to ensure that you are able to find what you need in this Owner's Manual as quickly as possible. The fastest way to find certain topics is by using the detailed index at the end. If you wish to gain only an initial overview of your vehicle, you will find this in the first chapter.

We hope that the detailed table of contents provided on the preceding pages will stimulate your interest and encourage you to read the manual.

Should you wish to sell your BMW at some time in the future, please remember to hand over this Owner's Manual to the new owner; it is part of the vehicle.

Should you have any further questions, your BMW center will be glad to assist at any time.

Symbols used



Indicates precautions that must be followed precisely in order to avoid the possibility of personal injury and serious damage to the vehicle. ◀



Contains information that will assist you in gaining the optimum benefit from your vehicle and enable you to care more effectively for your vehicle. ◀



Refers to measures that can be taken to help protect the environment. ◀

◀ Marks the end of a specific item of information.

* Indicates special equipment, country-specific equipment and optional extras.



Identifies index entries that refer to owner service procedures or topics on vehicle maintenance.



Identifies systems or components, which can either be activated or adapted to suit an individual driver's requirements ("Vehicle Memory", "Key Memory"). Refer to page 55. Remember that activation and adjustments on some of these systems can only be performed at your BMW center. ◀

Your individual vehicle

In selecting your BMW you have decided to purchase a specific model with its own individual range of equipment. This Owner's Manual will describe all of the equipment that the BMW M3 has to offer you.

We therefore request your understanding for the fact that this manual describes equipment and features that you might not have chosen for your vehicle. You can easily identify any differences with the aid of the asterisk * used to identify all optional equipment and accessories.

If your BMW features equipment that is not described in this Owner's Manual (a car radio or telephone, for instance), we have enclosed Supplementary Owner's Manuals. We ask you to read these manuals as well.

Status at time of printing

BMW pursues a policy of continuous, ongoing development that is conceived to ensure that our vehicles continue to embody the highest quality and safety standards combined with advanced, state-of-the-art technology. It is therefore possible that some of your own vehicle's equipment and features may vary from those described in this manual. Nor can errors and omissions be entirely ruled out. We must therefore request your understanding for the fact that we are unable to recognize legal claims based on discrepancies between the data, descriptions and illustrations in this manual and your own vehicle's equipment.

For your own safety

 Use unleaded gasoline only. Fuels containing up to and including 10% ethanol or other oxygenates with up to 2,8% oxygen by weight (i.e. 15% MTBE or 3% methanol plus an equivalent amount of co-solvent) will not void the applicable warranties respecting defects in materials or workmanship. Field experience has indicated significant differences in fuel quality (volatility, composition, additives, for example) among gasolines offered for sale in the United States and Canada. The use of poor quality fuels may result in drivability, starting and stalling problems especially under certain environmental conditions, such as high ambient temperature and high altitude. Should you encounter driveability problems which you suspect could be related to the fuel you are using, we recommend that you respond by switching to a recognized high-quality brand. Failure to comply with these recommendations may result in unscheduled maintenance. Obey all applicable safety rules when you are handling gasoline. ◀



Important safety information!

For your own safety, use genuine parts and accessories approved by BMW.

When you purchase accessories tested and approved by BMW and Original BMW Parts, you simultaneously acquire the assurance that they have been thoroughly tested by BMW to ensure optimum performance when installed on your vehicle.

BMW warrants these parts to be free from defects in material and workmanship.

BMW will not accept any liability for damage resulting from installation of parts and accessories not approved by BMW.

BMW cannot test every product made by other manufacturers to ascertain whether it can be used on a BMW safely and without risk to either the vehicle, its operation, or its occupants.

Original BMW Parts, BMW Accessories and other products approved by BMW, together with professional advice on using these items, are available from all BMW centers.

Installation and operation of non-BMW approved accessories such as alarms,

radios, amplifiers, radar detectors, wheels, suspension components, brake dust shields, telephones (including operation of any portable cellular phone from within the vehicle without using an externally mounted antenna) or transceiver equipment (such as CB, walkie-talkie, ham radio or similar) may cause extensive damage to the vehicle, compromise its safety, interfere with the vehicle's electrical system or affect the validity of the BMW Limited Warranty. See your BMW center for additional information.

Do not use key or remote control to lock doors or luggage compartment with anyone inside the vehicle. Refer to page 33 for more details. ◀

Symbol on vehicle parts



Indicates that you should consult the relevant section of this Owner's Manual for information on a particular part or assembly.

The following applies only to vehicles owned and operated in the US.

REPORTING SAFETY DEFECTS

If you believe that your vehicle has a defect that could cause a crash or could cause injury or death, you should immediately inform the National Highway Traffic Safety Administration (NHTSA) in addition to notifying BMW of North America, LLC, P.O. Box 1227, Westwood, New Jersey 07675-1227, Telephone (201) 307-4000.

If NHTSA receives similar complaints, it may open an investigation, and if it finds that a safety defect exists in a group of vehicles, it may order a recall and remedy campaign. However, NHTSA cannot become involved in individual problems between you, your dealer, or BMW of North America, LLC.

To contact NHTSA, you may either call the Auto Safety Hotline toll-free at 1-800-424-9393 (or 366-0123 in Washington, D.C. area) or write to: NHTSA, U.S. Department of Transportation, Washington, D.C. 20590. You can also obtain other information about engine vehicle safety from the Hotline.



Overview

Controls and features

Operation, maintenance

Owner service procedures

Technical data

Index



14 Cockpit

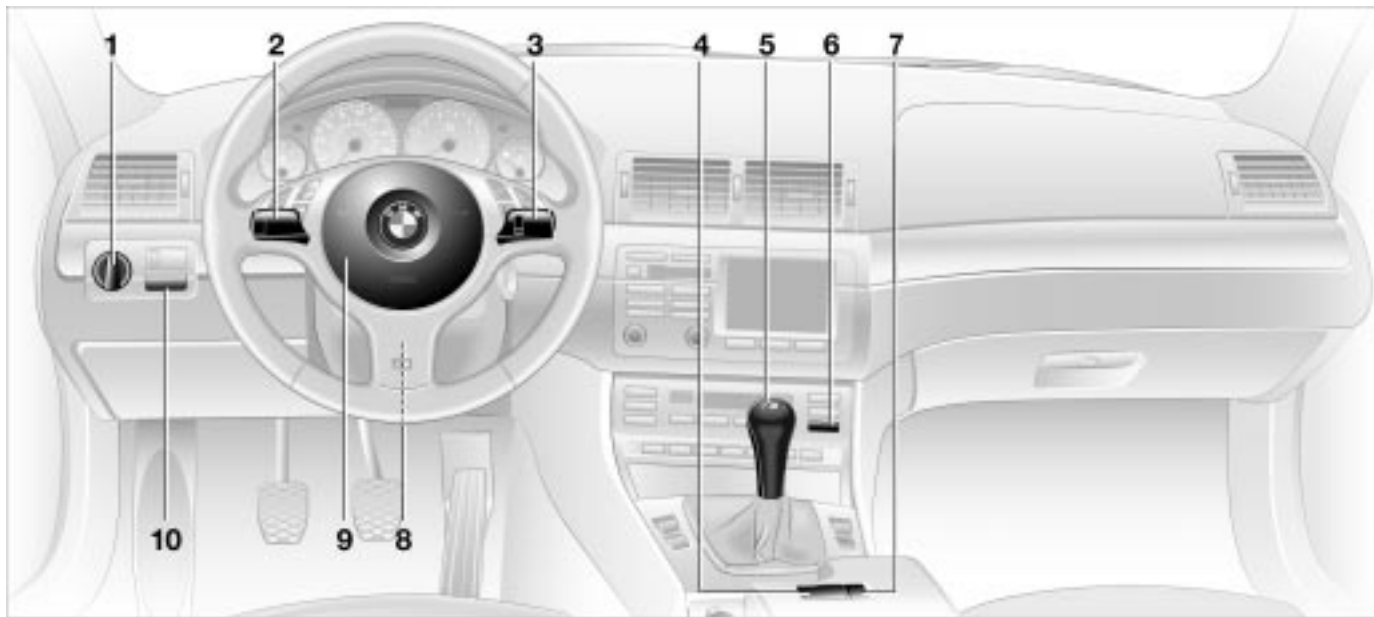

1 Parking lamps/Low beams [80](#)

2 ▷ Turn signal indicator [65](#)

▷ Standing lamps [81](#)

▷ High beams [81](#)

▷ Headlamp flasher [65](#)

▷ Computer [72](#)

3 Washer/Wiper system/Rain sensor [66](#)

4 Hazard warning flashers

5 Gearshift lever [58](#)

6 Rear window defroster [84](#), [88](#)

7 Central locking system [28](#)

8 Steering wheel [47](#)

9 Horn: the entire surface

10 Fog lamps [82](#)



- | | | |
|---|--|---|
| <p>1 Fuel gauge 71</p> <p>2 Turn signal indicator 20</p> <p>3 Speedometer</p> <p>4 Indicator and warning lamps 17 to 20</p> | <p>5 Tachometer and engine oil temperature gauge 70</p> <p>6 Engine coolant temperature gauge 71</p> <p>7 Indicator and warning lamps 17 to 20</p> | <p>8 Control button for
 ▷ Clock 73
 ▷ Unit of measure of outside temperature display 73</p> <p>9 Display for sequential M gearbox* SMG II 61</p> |
|---|--|---|

16 Instrument cluster



10 Indicator lamp for Dynamic Stability Control (DSC) [19](#)

- 11 Display for
- ▷ Odometer [70](#)
 - ▷ Trip odometer [70](#)
 - ▷ Clock [73](#)
 - ▷ Service Interval [71](#)

12 Display for computer, operation using the turn signal lever, refer to page [72](#):

- ▷ Outside temperature
- ▷ Average fuel consumption
- ▷ Range
- ▷ Average speed

12 Display for Check Control [72](#)

13 Trip odometer, reset to zero [70](#)

14 Indicator and warning lamps [17](#) to [20](#)

Indicator and warning lamps

Technology that monitors itself

Indicator and warning lamps that are identified by "●" are tested for proper functioning whenever the ignition key is turned. They each light up once for different periods of time.

If a fault should occur in one of these systems, the corresponding lamp does not go out after the engine is started or it lights up while the vehicle is moving. You will see how to react to this below.

Red: stop immediately



Battery charge current ●
The battery is no longer being charged. Indicates a defective alternator drive belt or a problem with the alternator's charge circuit. Please contact the nearest BMW center.



▲ If the drive belt is defective, do not continue driving, as the engine could sustain serious damage from overheating. If the drive belt is defective, increased steering effort is also required. ◀



Engine oil pressure ●
Stop the vehicle immediately and switch off engine. Check the engine oil level and top up as required. If the oil level is correct, please contact the nearest BMW center.



▲ Do not continue driving, as the engine could sustain serious damage from inadequate lubrication. ◀



Flat Tire Monitor ●
In addition, an acoustic signal sounds: a tire failure has occurred. Reduce vehicle speed immediately to stop the vehicle. Avoid hard brake applications. As you steer the vehicle, use caution and avoid overcorrecting.
For additional information, refer to page [77](#)



Brake warning lamp ●
If the lamp comes on when the parking brake is not engaged: check the brake fluid level. Before driving further, be sure to read the notes on pages [102](#) and [113](#)



Brake warning lamp for Canadian models.

18 Indicator and warning lamps

Red: an important reminder



Parking brake

Comes on when the parking brake is engaged – an additional acoustic signal sounds when starting off.

For additional information, refer to page [58](#)



Parking brake warning lamp for Canadian models.



Please fasten safety belts ●

A warning signal will sound at the same time. Lights up for a few seconds or until the safety belt is fastened.

For additional information on safety belts, refer to page [45](#)



Airbags ●

Please have the system inspected by your BMW center.

For additional information, refer to page [49](#)

Red and yellow: continue driving cautiously



If the brake warning lamp comes on together with the yellow indicator lamps for ABS and DSC:



The entire ABS, CBC and DSC control system has failed.



Continue driving cautiously and defensively. Avoid hard brake applications. Please have the system checked by your BMW center as soon as possible.

For additional information, refer to pages [76](#), [101](#).



ABS, CBC and DSC indicator and warning lamps for Canadian models.



Orange: consult the nearest BMW center



Sequential M gearbox* SMG II
If the indicator lamp fails to go out after the engine is started: this indicates a malfunction in the system. Please consult the nearest BMW center.

Indicator lamp flashes: a system overload has occurred.

For additional information, refer to page [64](#)

Indicator and warning lamps

Yellow: check as soon as possible



Antilock Brake System (ABS) ●

In addition, an acoustic signal sounds: ABS has been deactivated in response to system malfunction. Conventional braking efficiency is available and unrestricted. Please have the system inspected by your BMW center.

For additional information, refer to page [101](#)



ABS warning lamp for Canadian models.



Engine oil level

Comes on while driving: the engine oil level has fallen to the absolute minimum; refill as soon as possible. Do not drive more than 30 miles (50 km) until you do.

For additional information, refer to page [110](#)



Engine oil level

Comes on after the engine has been switched off: refill engine oil at the earliest opportunity (next time you stop for gas).

For additional information, refer to page [110](#)



Brake pads ●

Have the brake pads checked. For additional information, refer to page [102](#)



Flat Tire Monitor ●

The Flat Tire Monitor has been deactivated, either at the button or in response to a system malfunction. In the event of a malfunction, have the system checked by your BMW center. For additional information, refer to pages [24](#), [77](#)



Dynamic Stability Control (DSC) ●

The indicator lamp flashes and an acoustic signal sounds: the system is active and governs drive force and braking force. If the indicator lamp fails to go out after the engine is started, or if it comes on during normal driving and stays on: DSC has been deactivated, either at the button or in response to a system malfunction.

In the event of a malfunction, have the system checked by your nearest BMW center. For additional information, starting on page [76](#)



Dynamic Brake Control (DBC) ●

Malfunction in DBC system. Conventional braking efficiency is available and unrestricted. Have the system checked and repaired at your BMW center as soon as possible.

For additional information, refer to page [76](#)



Dynamic Brake Control (DBC) warning lamp for Canadian models.



Add washer fluid

The washer fluid is too low. Top up the fluid at the earliest opportunity.

For additional information, refer to page [109](#)



Add coolant

The coolant level is too low. Add coolant at the earliest opportunity.

For additional information, refer to page [112](#)

20 Indicator and warning lamps



Service Engine Soon ●

If the indicator lamp comes on either continuously or intermittently, this indicates a fault in the emissions-related electronic systems.

Although the vehicle remains operational, you should have the systems checked by your BMW center at the earliest possible opportunity.

For additional information, refer to page [116](#)



Service Engine Soon warning lamp for Canadian models



Engine electronics ●

There is a fault in the electronic engine-management system.

The electronics allow for continued driving with reduced engine output or engine speed. Please have the system inspected by your BMW center.



Check Filler Cap* ●

If the indicator lamp comes on although the fuel filler cap is secured correctly: this indicates a malfunction in the fuel system. Have the system inspected at your BMW center at the earliest opportunity.

For additional information, refer to page [23](#)

Green: for your information



Turn signal indicator

Flashes when the turn signal indicators are operated. Rapid flashing: indicates a system malfunction.

For additional information, refer to page [65](#)



Cruise control

Lights up when the cruise control is activated. Available for operation via the multifunction steering wheel.

For additional information, refer to page [68](#)



Front fog lamps

Lights up whenever the fog lamps are on.

For additional information, refer to page [82](#)

Blue: for your information



High beams

Comes on when the high beams are on or the headlamp flasher is actuated.

For additional information, refer to pages [65](#), [81](#).

Steering wheel with multifunction buttons

The buttons integrated in the multifunction steering wheel (MFL) are provided so that you can operate a number of accessories quickly and without being distracted from traffic conditions. You may operate:

- ▷ selected radio functions
- ▷ the cruise control
- ▷ selected cellular phone functions*
- ▷ the voice entry system*.

 The buttons are active only when the corresponding systems and accessories are switched on. ◀



Press briefly:
Receive a phone call, initiate dialing, terminate a call.
Extended pressure:
Activate/deactivate voice entry.



Switch between phone and radio, cassette, CD or MD.



Forward:

- ▷ Radio
 - Press briefly: station search in FM band
 - Extended pressure: search function
- ▷ CD/MD
 - Press briefly: jump to next track
 - Extended pressure: search function in track
- ▷ Cassette
 - Press briefly: stop jump to next track or fast forward
 - Extended pressure: fast forward
- ▷ Phone
 - Scan personal phone book.



Rewind: functions as forward.



Volume



Cruise control: to select a stored setting.



Cruise control: store and accelerate (+) or decelerate and store (-).



Cruise control: activate/interrupt/deactivate.

22 Warning triangle*

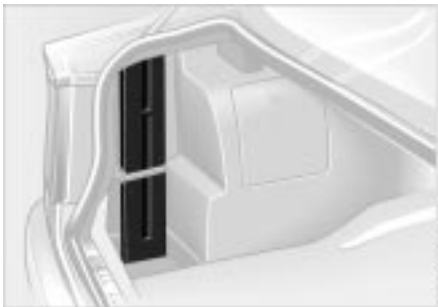

The hazard warning triangle is stored in a storage compartment on the left-hand side of the luggage compartment.

 Always observe all legal regulations requiring a warning triangle to be carried in the vehicle. ◀

First-aid kit*



The first-aid kit is located under the front passenger's seat.

To open: pull the handle and fold the cover down.

To close: fold the cover up.

 Several of the items contained in the first-aid kit have a limited service life. You should check the expiration dates of each of the items regularly, and replace any with passed dates. You can acquire replacements in any drugstore or pharmacy. Always observe all legal regulations requiring a first-aid kit to be carried in the vehicle. ◀

Refueling



Fuel filler door

 Always switch off the engine before refueling, as it is not possible to add fuel with the engine running, and attempts may also trigger the Service Engine Soon lamp. ◀

Press on the rear edge of the fuel filler door to open and close it.

If an electrical malfunction occurs, you can unlock the fuel filler door manually: Pull the knob with the fuel pump symbol on the right trim panel of the luggage compartment.

Refueling

 When handling fuels, comply with all of the applicable safety precautions and regulations pertaining to fuels.

Never carry spare fuel containers in your vehicle. Whether empty or full, these containers can leak, cause an explosion, or lead to fire in the event of a collision. ◀



Simple and environmentally friendly

 Open the filler cap carefully to prevent fuel from spraying out. Fuel spray may cause injury. ◀

Keep the filler cap in the bracket attached to the fuel filler door.

When refueling, insert the filler nozzle completely into the filler pipe. Pulling the nozzle out of the pipe during refueling

- ▷ results in premature pump shutoff
- ▷ will reduce the effect of the vapor recovery system on the pump.

As long as the filler nozzle is used properly, the fuel tank is full whenever the nozzle shuts off the first time.

Fuel tank capacity

- ▷ approx. 16.6 gal. (63 liters), incl.
- ▷ a reserve capacity of approx. 2.1 gal. (8 liters).

 Refill early to avoid damaging the catalytic converter; never attempt to drive to the last drop of fuel in the tank. ◀

 Close the fuel cap carefully after refueling until a "click" is heard. While closing, be sure not to squeeze the strap which is fastened to the cap. A loose or missing cap will activate the Check Filler Cap lamp*. ◀

24 Fuel specifications

Refuel with lead-free

The engine uses lead-free gasoline only.

Required fuel:

- ▷ Premium Unleaded Gasoline, min. 91 AKI
AKI = Anti Knock Index

 Never use leaded fuel, as it would cause permanent and irreversible damage to the oxygen sensor and the catalytic converter. ◀

Tire inflation pressures



The specified inflation pressures are provided on a sticker attached to the B-pillar and visible with the driver's door open.

Check tire pressures

On the next page you will find all the tire pressure and ambient air temperature specifications stated in the units usually used in your country (psi; kilopascal).

After correcting the tire inflation pressure, reinitialize the Flat Tire Monitor so that it can monitor the tire inflation pressure, refer to page [77](#).



Check the tire pressures on a regular basis – at least twice a month – and before every extended journey. Incorrect tire pressure can otherwise lead to driving instability, tire damage and accidents. ◀

Comply with tire approval specifications

The inflation pressures apply to BMW approved tire sizes and tire manufacturers. Your BMW center is familiar with these pressures. Higher pressures may be specified for tires made by other manufacturers.

Your vehicle is equipped with tires that not only meet US standards, but also European standards. We recommend the exclusive use of BMW approved tires.

Tire inflation pressures

Tires

All pressure specifications in the table are indicated in psi (kilopascal) with cold tires (cold = ambient temperature)



225/45 ZR 18	2.3 (230/33)	-	2.8 (280/41)	-
255/44 ZR 18	-	2.4 (240/35)	-	3.3 (330/48)
225/45 ZR 18	2.3 (230/33)	-	2.8 (280/41)	-
225/40 ZR 19	2.3 (230/33)	-	2.8 (280/41)	-
255/35 ZR 19	-	2.4 (240/35)	-	3.3 (330/48)
225/45 R 17 91 Q/T/H M+S	2.3 (230/33)	2.6 (260/38)	2.5 (250/36)	3.2 (320/46)



Overview

Controls and features

Operation, maintenance

Owner service procedures

Technical data

Index

Overview

Controls

Maintenance

Repairs

Data

Index



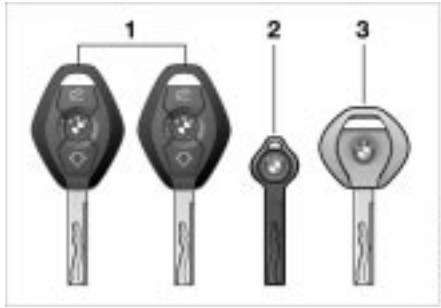

The key set

1 The master keys with remote control determine the functions of the Key Memory, refer to page 55.

You can mark individual keys for subsequent identification by applying the colored decals that you received when accepting delivery of your vehicle

▶ There is an extended-life battery in every master key that is charged automatically in the ignition lock as you drive. For this reason, if you have a master key that is otherwise not used, use that key at least once every year while driving for an extended period to charge the battery, also refer to page 30. ◀

- 2 Spare master key for storage in a safe place, such as in your wallet. This key is not intended for constant use
- 3 Door and ignition key
The locks for the luggage compartment lid and the glove compartment cannot be operated with this key – this is recommended for valet parking, for instance

Central locking system

The concept

The central locking system is ready for operation whenever the driver's door is closed. The system engages and releases the locks on the

- ▷ doors
- ▷ luggage compartment lid
- ▷ fuel filler door.

The central locking system can be operated

- ▷ from outside via the door lock and using the remote control
- ▷ from inside by pressing a button.

If it is operated from inside, the fuel filler door will not be locked, refer to page 33.

When the system is actuated from outside the vehicle, the anti-theft system is simultaneously activated. Both the door locks and release handles remain locked. The alarm system is also armed or disarmed.

Information for your safety: if locked from inside, the central locking system unlocks automatically in the event of an accident. In addition, the hazard warning flashers and interior lamps come on.

Opening and closing – via the door lock



With the key

Turning the key once in the driver's door will unlock only the driver's door. Turning the key a second time will unlock the passenger's door, the luggage compartment lid and the fuel filler door.



You can have a signal set to confirm that the vehicle's locks have engaged securely. ◀

Convenience operating mode

You can also operate the windows and the sliding/tilt sunroof via the door lock.

To open: with the door closed, hold the key in the "Unlock" position.

To close: with the door closed, turn the key to the "Lock" position and hold it.



Watch during the closing process to be sure that no one is inadvertently injured. Releasing the key stops the operation. ◀

Manual operation

(in the event of electrical malfunction)

Turn the key all the way to the extreme left or right to unlock/lock the driver's door.

30 Opening and closing – via the remote control

The concept

The remote control gives you an exceptionally convenient method for unlocking and locking your vehicle. Furthermore, it provides two additional functions which you can only execute via the remote control:

- ▷ Switch on the interior lamps, refer to page 31.

With this function, you can also "search for" your vehicle – when parked in an underground garage, for instance

- ▷ Open the luggage compartment lid, refer to page 31.

The luggage compartment lid will open slightly, regardless of whether it was locked or unlocked.

The anti-theft system is also deactivated/activated simultaneously with the unlocking or locking of the vehicle, the alarm system is disarmed/armed, and the interior lamps are switched on/off.



You can have a signal set to confirm that the vehicle's locks have engaged securely. ◀



- 1 Unlock, convenience mode opening and alarm system
- 2 Lock and secure, switch on interior lamps, deactivating tilt alarm sensor and interior motion sensor
- 3 Open the luggage compartment lid, panic mode (trigger alarm)

Master key with remote control



Since passengers or animals remaining in the vehicle might be able to lock the doors from the inside, take the vehicle's keys with you so that the vehicle can be opened again from the outside at any time. ◀



Master keys that are used repeatedly are always ready for operation, since the battery in the key is charged automatically in the ignition lock as you drive.

If it is no longer possible to unlock the vehicle via the remote control, the battery is discharged. Use this key while driving for an extended period in order to recharge the battery, refer also to page 28.

Guard the remote control against unauthorized use by only surrendering the spare key or the door key (refer to page 28) e.g. for valet parking.

In the event of a system malfunction, please contact your BMW center. You can also obtain replacement keys there. ◀

Opening and closing – via the remote control

To release



Press button.

After unlocking the driver's door, press button twice to unlock the entire vehicle.

Convenience opening mode



Press and hold button. The windows and the sliding/tilt sunroof are then opened.

To lock and secure



Press button.

To switch on the interior lamps



After locking the vehicle, press button again.

To deactivate the tilt alarm sensor* and interior motion sensor*



Press button a second time immediately after locking.

For additional information, refer to page 38.

To open the luggage compartment lid



Press button.

The lid will open slightly, no matter whether it was locked or unlocked.

 Before and after a trip, be sure that the luggage compartment lid has not been opened unintentionally. ◀

Panic mode (trigger alarm)



By pressing button for more than 2 seconds, the alarm can be sounded in the event of danger, if it is armed.

To switch off the alarm:



Press button.

32 Opening and closing – via the remote control

External systems

External systems or devices may cause local interference in the functions of the remote control.

Should this occur, you can still open and close the vehicle using the master key in both the door and luggage compartment lid locks.

For US owners only

The transmitter and receiver units comply with part 15 of the FCC (Federal Communication Commission) regulations. Operation is governed by the following:

FCC ID: LX8EWS
LX8FZVS
LX8FZVE

Compliance statement:

This device complies with part 15 of the FCC Rules. Operation is subject to the following two conditions:

- ▷ This device may not cause harmful interference, and
- ▷ this device must accept any interference received, including interference that may cause undesired operation.





Any unauthorized modifications to these devices could void the user's authority to operate this equipment. ◀

Opening and closing – from the inside



With this button you operate the central locking system whenever the doors are closed. The doors and luggage compartment lid are unlocked or locked only. The anti-theft system is not activated.

 If only the driver's door was unlocked from the outside and you press the button, then, with the driver's door still open, the passenger's door, the luggage compartment lid and the fuel filler door will unlock, too. If the driver's door is closed, it will be locked. ◀

 If you desire, the central locking system will secure the locks as soon as you start to drive. This can be adjusted to be key-specific. ◀

To unlock and open the doors

- ▷ Either unlock the doors together with the button for the central locking system and then pull each of the release handles above the armrests or
- ▷ pull the release handle for each door twice: the first pull unlocks the door, and the second one opens it.

To engage the locks

- ▷ Either use the central locking button to lock all doors at once or
- ▷ press down the individual door lock buttons. To prevent the driver from being inadvertently locked out of the vehicle, the driver's door lock button will not engage as long as the door is open.

 Since passengers or animals remaining in the vehicle might be able to lock the doors from the inside, take the vehicle's keys with you so that the vehicle can be opened again from the outside at any time. ◀

34 Luggage compartment lid



The lock

Only the master keys (refer to page 28) fit in the lock for the luggage compartment lid.

To secure separately

Turn the master key to the right past the resistance point and then pull it out in the horizontal position.

This locks the luggage compartment lid and disconnects it from the central locking system. This feature can be used to prevent unauthorized access to the luggage compartment when you hand over the door and ignition key (refer to page 28). This is useful for valet parking, for instance.

To open from the outside

Press the button in the handle recess (arrow): the luggage compartment lid opens slightly.

The luggage compartment is lighted when the luggage compartment lid is opened.

Manual operation

(in the event of electrical malfunction)

Turn the master key to the right as far as it will go, the luggage compartment lid will open slightly.

The luggage compartment lid is locked again as soon as you close the lid.



To open from the inside

If the luggage compartment lid has not been locked separately, you can open it with this button in the footwell on the driver's side when the vehicle is stationary.

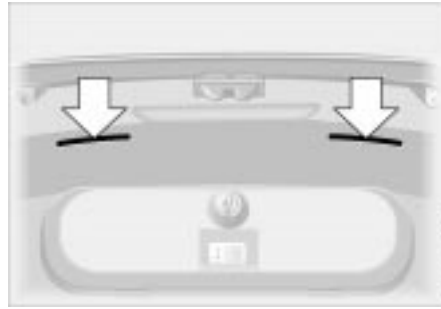

To close

The handle recesses in the interior trim panel of the luggage compartment lid (arrows) make it easier to pull the lid down.

 To avoid injuries, be sure that the travel path of the luggage compartment lid is clear when it is closed, as with all closing procedures. ◀

 Operate the vehicle only when the luggage compartment lid is completely closed. Otherwise, exhaust fumes could penetrate the interior of the vehicle. Should it be absolutely necessary to operate the vehicle with the luggage compartment lid open:

- ▷ Close all windows and the sliding/tilt sunroof
- ▷ Increase the air supply for the air conditioner or automatic climate control to a high level, refer to pages [83](#), [86](#). ◀

36 Luggage compartment lid Luggage compartment



Emergency release

This lever releases the luggage compartment lid from the luggage compartment's interior.



Lift the floor panel up and hook it

To raise and secure the floor panel, lift it by the ring and hook it into the rubber seal of the run-off gutter with the hanger (arrow).

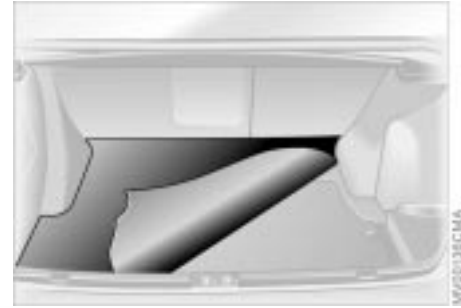

Floor mat

You can turn the floor mat over if required (for transporting soiled objects for instance). The rubberized side may be washed. It reduces movement of objects placed on it.

To secure your luggage, use the luggage nets* or flexible straps that you can attach to the fittings at the inner corners of the luggage compartment.

Refer also to "Cargo loading" on page [96](#).

Alarm system*

The concept

The vehicle alarm system responds:

- ▷ When a door, the hood or the luggage compartment lid are opened
- ▷ To movement inside the vehicle (interior motion sensor)
- ▷ To variations in the vehicle tilt, as would occur while attempting to steal the wheels or tow the vehicle (tilt alarm sensor)
- ▷ To interruption of battery voltage.

The system responds to unauthorized vehicle entry and attempted theft by simultaneously activating the following:

- ▷ Sounding an acoustic alarm for 30 seconds
- ▷ Activating the hazard warning flashers for approx. five minutes
- ▷ Flashing the high beams on and off in rhythm with the hazard warning flashers.

To arm and disarm the alarm system

When the vehicle is locked or unlocked by using a key or the remote control, the alarm system is also simultaneously armed or disarmed.



You can have a signal set as acknowledgment for both arming and disarming the alarm. ◀



You can also open the luggage compartment lid when the system is armed by pressing the button of the remote control, refer to page 31. When it is closed, the lid is once again secured.



Indicator lamp displays

The indicator lamp is located under the interior rearview mirror.

- ▷ When the indicator lamp flashes continuously: the system is armed
- ▷ The indicator lamp flashes when it is armed: the door(s), the hood or luggage compartment lid are not completely closed. Even if you do not close the alerted area, the remaining areas are secured, and the indicator lamp flashes continuously after 10 seconds. However, the interior motion sensor is not activated
- ▷ If the indicator lamp goes out when the system is disarmed: no manipulation or attempted intrusions have been detected in the period since the system was armed

38 Alarm system*

- ▷ If the indicator lamp flashes for 10 seconds when the system is disarmed: an attempted entry has been detected in the period since the system was armed.

Following triggering of an alarm, the indicator lamp will flash continuously.

Avoiding unintentional alarms

The tilt alarm sensor and interior motion sensor can be deactivated together. Doing this prevents a false alarm from being triggered, e.g. in garages with elevator ramps or when the vehicle is being transported on a car train:

Lock the vehicle twice (= arm the system). Press button 2 on the remote control twice in succession or lock the vehicle twice with the key, refer to page [31](#).

The indicator lamp lights up briefly and then flashes continuously. The tilt alarm sensor and the interior motion sensor are deactivated as long as the system is armed.

Arm the alarm system again to reactivate the tilt alarm sensor and the interior motion sensor.

Interior motion sensor

In order for the interior motion sensor to function properly, the windows and sliding/tilt sunroof must be completely closed.

Nevertheless, you should deactivate the interior motion sensor (refer to "Avoiding unintentional alarms") if you

- ▷ leave children or animals in the vehicle
- ▷ the windows or sliding/tilt sunroof should be left open.

Electric power windows



To open and close the windows

From ignition key position 1:

To open:

- ▷ Press the switch up to the resistance point: the window will lower slightly or the vent windows will open slightly, as long as you keep pressing the switch
- ▷ Press the switch briefly past the resistance point: the window moves automatically. Pressing the switch again stops the opening cycle.

To close: you can close the windows in the same manner by pulling the switch. The vent window does not close automatically.

After the ignition has been switched off: You can still operate the electric power windows for up to 15 minutes, provided that no door has been opened.

 When leaving the vehicle, always remove the ignition key from the lock and remember to close the doors to prevent children from operating the power windows and injuring themselves. ◀

To use the convenience mode via the door lock or the remote control, refer to pages [29](#) and [31](#).

Safety feature

A contact strip is located on the inside upper frame of each of the windows. If pressure is exerted against this contact strip while a window is being raised, the system will respond by stopping the window and then retracting it a small distance.

 Despite this safety feature, be extremely careful to ensure that the closing path of the window is not obstructed. Otherwise, an object might not touch the contact strip in some situations (very thin objects, for instance). You can disable this safety feature by pressing the switch beyond the resistance point and holding it. ◀

40 Sliding/tilt sunroof*

 To prevent injuries, exercise care when closing the sliding/tilt sunroof and keep it in your field of vision until it is shut.

When leaving the vehicle, always remove the ignition key from the lock and remember to close the doors to prevent children from operating the sliding/tilt sunroof and injuring themselves. ◀



Lifting - opening - closing

From ignition key position 1:

Lifting/opening/closing: press the switch or slide it to the desired direction until you feel resistance.

When the roof is open, tap the switch in the "lift" direction. The sunroof will then go into the end position for "lifting."

The headliner insert slides back somewhat when you raise the sunroof. When the sunroof is opened, the headliner retracts with it.

 The headliner insert cannot be closed with the sunroof in its raised position. ◀

After switching the ignition off, you can operate the sunroof for up to 15 minutes, as long as no door is opened during that time.

For the convenience mode via the door lock or the remote control, refer to pages [29](#) and [31](#).

Automatic opening and closing

Press the switch past the resistance point: the sunroof travels to either the fully-closed or fully-open position.

Pressing the switch again stops the motion immediately.

Sliding/tilt sunroof*

Safety feature

If the sliding/tilt sunroof encounters resistance

- ▷ when it is closing from the raised position
- ▷ when it is closing from a point roughly past the middle of its travel, the closing cycle is interrupted and the sliding/tilt sunroof will open again slightly.

 Despite this safety feature, be extremely careful to ensure that the closing path of the roof is not obstructed. Otherwise, triggering the closing-force limitation may not be ensured in some situations (with very thin objects, for instance). You can disable this safety feature by pressing the switch beyond the resistance point and holding it. ◀

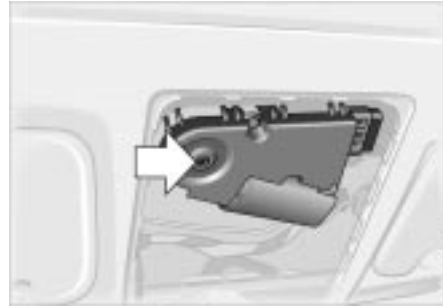

Manual operation

In the event of an electrical malfunction, you can also operate the sliding/tilt sunroof manually

1. Remove the interior lamp, then reach into the exposed opening and press out the cover
2. Use an Allen wrench from the onboard tool kit (refer to page 120) to turn the sunroof's steel crank in the desired direction.

42 Correct sitting position

For relaxed and fatigue-free driving you should select a sitting position that reflects your personal requirements. Correct sitting position combined with safety belts and airbags enhances occupant safety in the event of an accident. To ensure that the vehicle's safety systems provide you with optimal protection, we request that you direct your careful attention to the following section.

For additional information on transporting children, refer to page [52](#).

Sitting correctly with airbags

 Maintain a distance to the airbags. Always hold the steering wheel by the rim to keep any chance of injury to hands or arms to an absolute minimum, should the airbag be deployed. No one and nothing is to come between the airbags and the seat occupant. Never use the front airbag's cover as a storage tray or support for objects of any kind. Never allow front passengers to rest their feet or legs on the airbag cover. ◀

For airbag locations and additional information on airbags, refer to page [49](#).

Safe with safety belts

 Never allow more than one person to wear a single safety belt. Never allow infants or small children to ride in a passenger's lap. Avoid twisting the belt while routing it firmly across the hips and shoulder, wear it as snugly against your body as possible. Do not allow the belt to rest against hard or fragile objects. Do not route the belt across your neck, or run it across sharp edges. Be sure that the belt does not become caught or jammed. Avoid wearing bulky clothing and pull on the lap belt periodically to retension it over your shoulders. In the event of a frontal impact, a loose lap belt could slide over the hips, leading to abdominal injury. In addition, the safety belt's restraint effectiveness is reduced if the belt is worn loosely. Expectant mothers should always wear their safety belts, taking care to position the lap belt against the lower hips, where it will not exert pressure against the abdominal area. ◀

For information on using the safety belts, refer to page [45](#).

When adjusting your seat, always observe the following precautions

 Never try to adjust your seat while driving the vehicle. The seat could respond with unexpected movement, and the ensuing loss of vehicle control could lead to an accident. Never ride with the backrest reclined to an extreme angle (especially important for the front passenger to remember). If you do so, there is a risk that you will slide under the safety belt in an accident, thus reducing the protection provided by the safety belt. ◀



- 1 Tilt angle
- 2 Longitudinal adjustment
- 3 Cushion height
- 4 Backrest angle

The head restraint and the thigh support are adjusted manually.

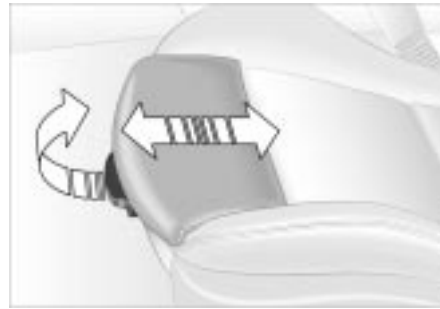

Thigh support

Pull the lever and adjust the position of the cushion for thigh support as desired.



Adjusting the lumbar support*

You can adjust the backrest's contour for additional support in the curvature of your spine's lumbar region.

The upper hips and spinal column receive supplementary support to help you maintain a relaxed, upright sitting position.

- ▷ Press the front/rear of switch: increase/decrease curvature
- ▷ press the upper/lower end of the switch: increase the upper/lower curvature.



Adjusting width of the backrest*

Use the controls found along the sides of the seat to adjust the width for the backrest. This way you can set the sides of the seat so that they conform to your body contours.

Decreasing or increasing the width of the backrest: press the front/rear of switch.

Head restraints

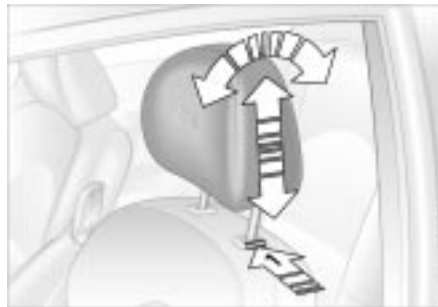

Adjustments

Height: pull the head restraint up or push it down.



In order to move to the lowest positions, press button 1. ◀

To adjust the angle of the front head restraints, tilt the head restraint to the desired angle.



Adjust the head restraint so that its center is approximately at the height of your ears, as otherwise the risk of damage to the cervical vertebra in an accident is increased. ◀

Removal

1. Pull the head restraint upward to the stop
2. Press button 1 and remove the head restraint.

Installation – front

Press button 1 and insert the head restraint into the guides.

Removal and installation – rear

Give the head restraint a sharp upward tug to release it from its locking mechanism. Press down forcefully to install.



Unlocking backrest

Pull up on the lever and push the backrest toward the front.

The outer levers hold the safety belt to enable it to be reached more easily.

 Lock both backrests while driving, otherwise there is a danger of an unexpected movement causing an accident. ◀



Drive with your safety belt on

Always fasten your safety belt before starting off. As supplemental restraint devices, the airbags are designed to enhance the effectiveness of the safety belts, and not to replace them.

To fasten

Make sure you hear the catch engage in the belt buckle.

To release

1. Press red button in the belt buckle
2. Hold the belt
3. Guide belt back into the inertia reel.

 In the rear, the belt buckle with the word "CENTER" is provided exclusively for the passenger sitting in the middle. ◀

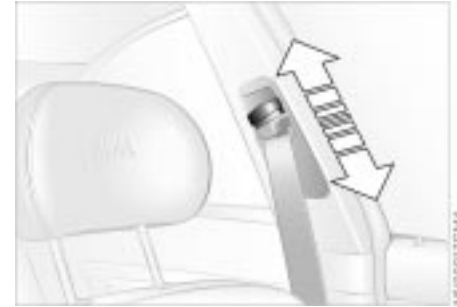

Safety belt height adjustment

Use the height adjustment mechanism to adapt the safety belt to the ideal position for your own body:

1. Press the button
2. Slide the entire assembly up or down.

Also observe the instructions on adjusting the seats on page 42.

 If the safety belt system has been subjected to the stresses involved in an accident or otherwise damaged: Have the entire safety belt mechanism replaced by your BMW center, including the safety belt tensioner. In addition, have your BMW center inspect the safety belt anchors. If a child-restraint system was in the vehicle during an accident, consult the manufacturer's instructions regarding replacement. ◀

Seat and mirror memory



You can store and call up three different driver's seat and exterior mirror positions.

 Memory will not retain the adjustments made to the lumbar supports or the width of the backrests. ◀

To store

1. Ignition key in position 1 or 2
2. Adjust your seat and outside mirrors to the desired position
3. Press the MEMORY button: the indicator lamp in the button lights up
4. Press memory button 1, 2 or 3, as desired. The indicator lamp goes out.

To select a stored setting

Driver's door open after unlocking or ignition key in position 1:

- ▷ Briefly press memory button 1, 2 or 3, as desired.
Movement stops immediately when one of the seat adjustment or memory buttons is activated during the adjustment process.

With the driver's door closed and the ignition key either removed or in position 0 or 2:

- ▷ Maintain pressure on the desired memory button (1, 2 or 3) until the adjustment process is completed.

 If you press the MEMORY button accidentally: press the button again; the indicator lamp goes out. ◀

 Do not select a memory position while the vehicle is moving. If you do so, there is a risk of accident from unexpected seat movement. ◀

Seat and mirror memory

 Your BMW center can adjust your vehicle's systems in such a manner that your personalized settings are automatically set for the seat and exterior mirror positions when you unlock the vehicle with your personal remote control. ◀

 Before activating the programmed adjustment feature ensure that the footwell behind the driver's seat is empty and unobstructed. If you fail to do so, any persons or objects behind the seat could be injured or damaged by a rearward movement of the seat. ◀

Seat heating*



The seat cushion and backrest can be heated when the ignition key is in position 2.

You can call up different heating levels by repeatedly pressing the button.

You can also switch the higher heating modes off directly:

Press the button and hold it slightly longer.

Steering wheel



Adjustments

1. Push the locking lever downward
2. Adjust the steering wheel (forward/back and up/down) to suit your sitting position
3. Pull the lever back in to clamp the steering wheel in the new position.

 Do not adjust the steering wheel while the vehicle is moving, otherwise there is a risk of an accident from unexpected movement. ◀

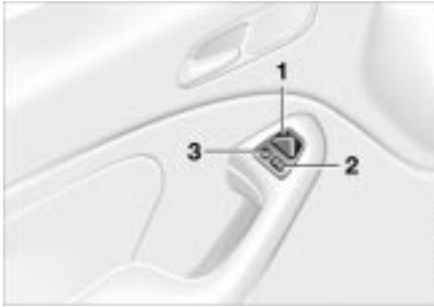

Adjusting outside mirrors

- 1 Switch for 4-way adjustment
- 2 Select or switch for changing between mirrors

Adjusting manually

The mirrors can also be adjusted manually: press the edges of the lens.

To store the mirror settings, refer to "Seat and mirror memory" on page [46](#).

Convex mirror

 The passenger-side mirror features a convex lens. When estimating the distance between yourself and other traffic, bear in mind that the objects reflected in the mirror are closer than they appear. This means that estimations of the distance to following traffic should not be regarded as precise. ◀



Self-defrosting mirrors

Both mirrors are heated automatically in ignition key position 2.

Passenger-side exterior mirror tilt function

(automatic curb monitor)

- ▷ Move the mirror selector switch 1 to the "driver's mirror" position
- ▷ When the selector lever is placed in "Reverse," the passenger-side mirror tilts downward. This brings e.g. the lower area adjacent to the vehicle (curbs, etc.) into the driver's field of vision while parking.

You can deactivate this automatic feature by setting the mirror selector switch to the "passenger-side" position.



For the mirror to function perfectly, keep the photocells clean and the area between the inside rearview mirror and the windshield free of any obstruction, like stickers, etc.

Interior rearview mirror with automatic dimming feature

This mirror automatically dims through an infinitely variable range and switches automatically to its clear, undimmed mode whenever you engage reverse gear.

There are two photocells for automatic dimming. One photocell (arrow) is positioned in the mirror's frame, while the other is slightly offset on the opposite side of the mirror.

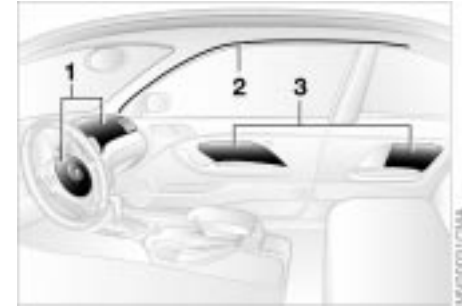

- 1 Front airbags on the driver and passenger sides
- 2 Side Impact Head Protection System on the driver and passenger sides (front)
- 3 Side airbags on the driver and passenger sides (front and rear*)

Protective effect

The front airbags protect the driver and passenger in the event of a frontal impact where the protection provided by the safety belt alone would not be adequate. The Side impact Head Protection System and the side airbags help provide protection in the event of a collision from the side. Each of the side airbags is designed to help support the seat occupant's upper body.

 The side airbags in the rear passenger area* of your vehicle may already have been deactivated either at the time of manufacture or by a BMW center. You may have them activated if you desire to do so. Please contact your BMW center for additional information. ◀

For information on the correct sitting position, refer to page [42](#).

 The airbags will not be triggered in the event of a minor accident, a vehicle rollover, or collisions from the rear. ◀

 Do not apply adhesive materials to the cover panels of the airbags, cover them or modify them in any other way. Do not attempt to remove the airbag restraint system from the vehicle. In the event of a malfunction, deactivation, or triggered actuation (as a response to an accident) of the airbag restraint system, consult your BMW center for checking, repairs or removal. Modifications may not be made on either the wiring or the individual components in the airbag system. These include the padded steering wheel hub, the instrument panel, the side trim panels of the front or rear doors and the roof pillars or the sides of the headliner. Do not attempt to remove or dismantle the steering wheel. To ensure compliance with official safety regulations, entrust disposal of airbag generators to a BMW center. Unprofessional attempts to service the system could lead to failure in an emergency or undesired airbag activation, either of which could result in personal injury. Do not touch the individual components directly after the system has been triggered, as otherwise there is a danger of burns. ◀

 At all times, occupants should sit upright and be properly restrained (infants and small children in appropriate child-restraint systems; larger children and adults using the safety belts). Never let an occupant's head rest near or on a side airbag because the inflating airbag could cause a serious or fatal injury. Please note that the word "Airbag" imprinted on the door trim panel indicates the airbag's location. Accident research shows that the safest place for children in an automobile is in the rear seat. However, a child sitting in the rear seat and not properly restrained may place his or her head on or near the side airbag, if so equipped. For example, a child – even though belted – may fall asleep with his or her head against the side airbag. It may be difficult for a driver to ensure that children in the rear seat will remain properly positioned at all times and not place their heads on or near the side airbag. Therefore, we recommend that the rear seat side airbags, if provided, be deactivated if you plan to transport children in the rear seat.

Airbags

The rear seat side airbags may already have been deactivated, either at the time of manufacture or by a BMW center. Labels in the rear door opening should indicate the status of your rear seat side airbags. If you are uncertain of their status, or wish to have the airbags activated or deactivated, please contact your BMW center. ◀

Even when all these guidelines are followed, there is still a small residual risk of injuries to the face, hands and arms occurring from airbag deployment in isolated instances. The ignition and inflation noise may provoke a mild temporary hearing loss in extremely sensitive individuals.

Airbag warning information is also provided on the sun visors.



This is the right way a child should sit in a child-restraint device when rear side airbags (arrow) are provided.



This is the right way a larger child should sit wearing the safety belt when rear side airbags (arrow) are provided.

Operational status

The indicator lamp in the instrument cluster displays the operational status of the airbag system from ignition key position 1.

System operational:

- ▷ The indicator lamp comes on briefly when you turn the ignition key to position 1 or higher.

System malfunction:

- ▷ The indicator lamp fails to come on, when the ignition key is turned
- ▷ The indicator lamp fails to go out after the engine has been started, or it comes on during normal driving.

Please respond to any malfunctions in the system by immediately having it inspected at your BMW center; otherwise the airbag could fail to respond to an accident in which both the angle and the severity of the impact would normally trigger airbag deployment.

Transporting children safely

Commercially available child-restraint systems are designed to be secured with a lap belt or with the lap belt portion of a combination lap/shoulder belt. Improperly or inadequately installed restraint systems can increase the risk of injury to children. Always read and follow the instructions that come with the system.

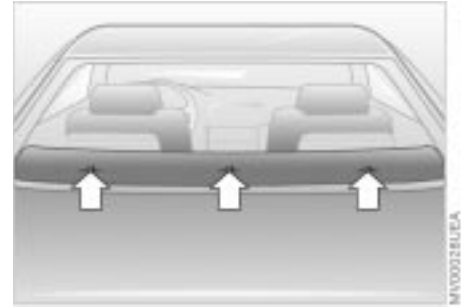

If you use a child-restraint system with a tether strap, three additional tether anchorage points have been provided (refer to the arrows in the illustration). Depending on the location selected for seating in the rear passenger area, attach the strap hook to the corresponding anchorage point to secure the child-restraint system. Remove the cover first on the middle location.

If the respective seating position is fitted with a head restraint lift the head restraint and pass the tether strap between the head restraint and the seat back.

Adjust the tether strap according to the child-restraint manufacturer's instructions.

Transporting children safely

 Before installing any child-restraint device or child seat, please read the following: Never install a rearward-facing child-restraint system in the front passenger seat of this vehicle. Your vehicle is equipped with an airbag supplemental restraint system for the front passenger. Because the backrest on any rearward-facing child-restraint system (of the kind designed for infants under 1 year and 20 lbs/9 kg) would be within the airbag's deployment range, you should never mount such a device in the front passenger seat, since the impact of the airbag against the child restraint's backrest could lead to serious or fatal injuries. If it is necessary for a child (not an infant) to ride in the front seat, certain precautions should be taken. First, move the passenger seat as far away from the instrument panel as possible. This important precaution is intended to maximize the distance between the airbag and the child. Older children should be tightly secured with the safety belt.

Younger children should be secured in an appropriate forward-facing child-restraint system that has first been properly secured with a safety belt. Never install a rearward-facing child-restraint system in the front passenger seat.

We strongly urge you to carefully read and observe the instructions for installation and use provided by the child-restraint's manufacturer whenever you use such a device.

Be sure that all occupants (of all ages) remain properly and securely restrained at all times. ◀

All rear seating positions in your vehicle meet the recommendations of SAE J1819, a industry recommended practice for securing child-restraint systems in motor vehicles.



LATCH child-restraint system installation

Remove the cover from the outside mount by pulling forward. When re-installing ensure that the recess is on the top.

54 Transporting children safely



The illustration shows the mounts for a LATCH child-restraint system in the right rear seat.

 To mount the LATCH child-restraint system, please follow the manufacturer's operating and safety precautions. ◀



Child seat security

All of the rear belt retractors and the front passenger's safety belt can be locked for mounting and securing child-restraint systems.

A label with the appropriate instructions for this is located in the immediate vicinity of the buckle latch of each safety belt.

Lock the safety belt

Extract the entire length of the belt from the inertia reel mechanism. Allow the reel to retract the belt somewhat and engage the buckle, then tighten the belt against the child-restraint system. The retraction mechanism is now locked. The belt cannot be extracted further. Always observe the installation instructions provided by the manufacturer of the child-restraint system.

Unlock the safety belt

Release the safety belt, remove the child-restraint device and retract the safety belt to its end position on the belt retractor.

Vehicle Memory, Key Memory



How the system functions

No doubt you have reflected at one time or another on how great it would be if you could permanently configure your vehicle's various features and adjustments to mirror your own individual preferences. In engineering your vehicle, BMW has incorporated a number of options for personal adjustment that can be programmed into your vehicle at your BMW center.

The available configuration data fall into two categories, according to whether their primary orientation is the vehicle ("Vehicle Memory") or the individual ("Key Memory"). Provided that each person has a separate remote-control key, you can have your BMW center enter adjustment data for as many as

four different individuals into the system.

The system then relies on a bilateral data exchange to identify the individual user and dial in the selected settings whenever the remote control unit is used to disengage the door locks.

Color-coded decals have been provided to help you distinguish individual keys with different settings.

What the system can do

Your BMW center can provide you with details on the possibilities that the Vehicle and Key Memory systems offer.

Examples for Vehicle Memory:

- ▷ Various signals as acknowledgment when locking or unlocking your vehicle, refer to pages [29](#), [30](#)
- ▷ Activate/deactivate the "Follow me home" lamps function, refer to page [80](#).

Examples for Key Memory:

- ▷ Locks the vehicle after driving off, refer to page [33](#)
- ▷ Automatically adjusts the seat and exterior mirrors to your personal programmed settings, refer to page [46](#)
- ▷ Calls up customized settings for the automatic climate control when unlocking using the remote control, refer to page [87](#)
- ▷ After the engine is started, calling up of the last selected driving program for each shifting mode, refer to page [63](#).



You will see this symbol throughout the Owner's Manual. It is to remind you at appropriate places of the settings that are available to you. ◀



Ignition key positions

- 0 Steering locked
- 1 Steering unlocked
- 2 Ignition switched on
- 3 Starting engine

Steering locked

The key can be inserted or removed in this position only.

After removing the key, turn the steering wheel slightly to the left or right until you hear the lock engage.

If the key is not removed, an acoustic signal is sounded after the driver's door has been opened.

The sound system remains operational for approx. 20 minutes after you switch off the ignition (ignition key in position 0 or key removed). Simply switch it back on.

Steering unlocked

You will find that it is often easier to turn the ignition key from position 0 to position 1 when you move the steering wheel slightly to help disengage the lock.

Individual electrical accessories are ready for operation.

Starting the engine

1. Engage the parking brake
2. Gearshift lever in idling position
3. Press the clutch pedal at low temperatures
4. Start the engine. Do not press the accelerator pedal. Do not actuate the starter for too short a time. Do not turn it for more than approx. 20 seconds. Release the ignition key immediately when the engine starts.

Do not allow the engine to warm up by leaving it running while the vehicle remains stationary. Instead, begin driving immediately at a moderate engine speed.

Vehicles with sequential M gearbox* SMG II: refer to the instructions on page 60.



Do not allow the engine to run in enclosed spaces. The exhaust gases contain carbon monoxide, an odorless and colorless, but highly toxic gas.

Breathing the exhaust gases poses an extreme health risk, and can lead to unconsciousness and death.

Do not leave the vehicle unattended with the engine running. An unattended vehicle with a running engine represents a potential safety hazard. ◀

Starting the engine

If the engine does not start on the first attempt (the engine is very hot or cold, for instance):

- ▷ Press the accelerator pedal halfway down while engaging the starter.

Cold starts at very low temperatures, starting at about +5°F (-15°C) and at high altitudes over 3,300 ft (over 1,000 m):

- ▷ On the first start attempt, engage the starter for a longer period (approx. 10 seconds)



Extended starting attempts, characterized by excessively frequent or long periods with the starter engaged, can lead to damage to the catalytic converter. ◀



When driving, standing at idle, and parking the vehicle, take care to avoid contact between the exhaust system and flammable materials (grass, hay, leaves, etc.). Such contact could lead to a fire, resulting in personal injury and property damage. ◀

Engine idle speed is controlled by the engine computer system. Increased speeds at start-up are normal and should decrease as the engine warms up. If engine speed does not decrease, service is required.

To prevent the battery from discharging, always switch off electrical devices that are not in use. Switch the ignition off when the vehicle is not being driven.

Switching off the engine 57

Turn the ignition key to position 1 or 0.



Do not remove the ignition key while the vehicle is still moving. If you did so, the steering lock would engage when the steering wheel is turned.

When you leave the vehicle, always remove the ignition key and engage the steering lock.

Set the parking brake when parking on steep hills, because under certain conditions, putting the vehicle into first or reverse gear may not be enough to prevent it from rolling away. ◀

Vehicles with sequential M transmission* SMG II: observe instructions on page 60.



The parking brake is primarily designed to prevent the vehicle from rolling while parked. It operates against the rear wheels.

To engage

The lever engages automatically, the indicator lamp in the instrument cluster comes on when the ignition key is in position 2, refer to page 18.

To release

Pull up slightly on the lever, press the button (arrow) and lower the lever.

⚠ If, in exceptional circumstances, it should be necessary to engage the parking brake while the vehicle is in motion, do not pull it with excessive pressure. Keep your thumb pressed against the release button while carefully pulling the lever up to apply moderate pressure.

Excessive pressure can lead to over-braking and loss of traction (fishtailing) at the rear axle.

The brake lamps do not come on when the parking brake is engaged.

Set the parking brake when parking on steep hills, because under certain conditions, putting the vehicle into first or reverse gear may not be enough to prevent it from rolling away. ◀

To avoid corrosion and one-sided braking, apply the parking brake lightly from time to time when coasting to a standstill (at a traffic signal, for instance), provided that it is safe to do so.



Press the clutch pedal all the way down each time you shift, pressing the manual gearshift lever into its proper end position.

⚠ When shifting gears in the 5th/6th-gear plane, be sure to press the gearshift lever to the right in order to prevent inadvertent selection of a gear in the 3rd/4th-gear plane. ◀

Manual transmission

Reverse

Select only when the vehicle is completely stopped. Press the gearshift lever to the left to overcome the slight resistance.

As you do this, the backup lamps will come on automatically when the ignition key is in position 2.



Do not hold the vehicle in place on slopes by slipping or "riding" the clutch. Use the parking brake instead. Riding the clutch causes the clutch assembly to wear out sooner. ◀

Sequential M gearbox* SMG II

The concept

The sequential M gearbox SMG II is an automated manual gearbox with which clutching and shifting is assumed by an electro-hydraulic system.

The SMG II is operated via two shift paddles on the steering wheel and the selector lever in the center console.

It offers the following functions:

- ▷ Sequential and automated shifting mode
- ▷ Ability to choose between different driving programs (Drivelogic)
- ▷ Gradient assistance
- ▷ Upshift display (shift lights)
- ▷ Throttle blip
- ▷ Driving dependent functions:
 - The respective driving situation (e.g. cornering, mountain driving, braking) is detected by sensors and taken into account accordingly for shifting, e.g. to achieve optimum gear selection during deceleration and subsequent acceleration

- ▷ Slip recognition at the rear axle for increasing driving stability, e.g. during downshifting on slippery road surfaces
- ▷ Operating safety through protection against misshifting.

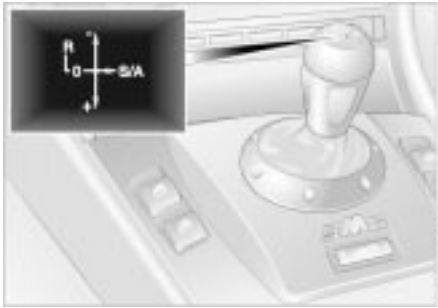

Selector lever position

R: Reverse position

0: Position 0

Forward position with one-touch mode:

▷ S: Sequential mode

▷ A: Automated mode

▷ +: Upshifting in sequential mode

▷ -: Downshifting in sequential mode.

The SMG II is ready for operation from ignition key position 2.

For your safety, it is only possible to engage a driving position with the vehicle stopped approx. 2 seconds after engaging the position 0 with the footbrake depressed (shift-lock function).

It is not necessary to hold the footbrake depressed until starting off, as the vehicle does not move forward with the driving position engaged.

Starting engine and driving off

To start the engine:

1. Depress footbrake
2. Move selector lever into position 0
3. Turn the ignition key to position 3, refer to page 56.

To drive off:

1. Depress footbrake
2. Engage a driving position
3. Release footbrake and slowly depress accelerator pedal.

 With the engine running, the gear indicator in the instrument cluster flashes to indicate that a driving position is engaged with the driver's door open or if the hood is not closed properly, refer to page 61.

If none of the pedals is actuated, then the gearbox is automatically taken out of gear after approx. 4 seconds.

Then the desired direction of travel must be selected again with the selector lever in position 0. ◀



Starting off is not possible with the hood open. ◀



Before exiting the vehicle with the engine running, move the selector lever into position 0 and apply the parking brake.

Never leave the vehicle unattended with the engine running. An unattended vehicle with a running engine represents a potential safety hazard. ◀

Switching off engine

If you turn the ignition key to position 1 or 0 with the selector lever in the forward or reverse position, a gear automatically remains engaged.

If you turn the ignition key to position 1 or 0 with the selector lever in position 0, a gong and the flashing gear indicator in the SMG display remind you that the vehicle is not secured against rolling.

Sequential M gearbox* SMG II

The warning stops after approx. 10 seconds. If you move the selector lever into a forward or reverse position during this time, a gear is automatically engaged.



The SMG II has no park position for securing the vehicle against rolling. The ignition key can be removed in any selector lever position. ◀



Always engage the parking brake when parking on downhill roads. Engaging a gear may not sufficiently secure the vehicle against rolling. ◀



Display in instrument cluster

The selector lever position, currently engaged gear and selected driving program are displayed in the instrument cluster.

- 1 Engaged gear
- 2 Selected driving program (corresponds to the number of illuminated fields), refer to page 64
- 3 Tapping the selector lever to the right switches over into the displayed shift mode
- 4 "A" indicates an activated automated mode.

R – Reverse position

Only engage with the vehicle stopped or at low speed, e.g. for "rocking free" in deep snow.

0 – Position 0

Always engage before starting the engine.

If the driving situation requires, e.g. when downshifting on slippery roads, the SMG II automatically disengages and reengages the clutch, i.e. it is not necessary to manually engage position 0.

S – Sequential mode

In the sequential mode all forward gears are to be shifted by the driver.

Changeover from automated to sequential mode:

- ▷ Tap the selector lever to the right toward "S" or
- ▷ change gears with the selector lever or the shift paddles on the steering wheel.

You do not need to reduce the throttle for shifting.

62 Sequential M gearbox* SMG II



Shifting gears with shift paddles on steering wheel:

- ▷ To upshift, briefly pull the right paddle "+"
- ▷ To downshift, briefly pull the left paddle "-."

 Shift paddles with various widths matched to the shape of your hand are available from your BMW center. ◀

Shifting gears with selector lever:

- ▷ To upshift, pull the selector lever backward "+"
- ▷ To downshift, push the selector lever forward "-".

No automatic upshifting is carried out in the sequential mode.

You accelerate from higher gears, e.g. during passing, by manually downshifting.

In the following situations the SMG II helps you "think" in the sequential mode:

- ▷ Upshifts and downshifts are only executed when the new gear will provide a suitable combination of vehicle and engine speed, i.e., downshifts that would cause the engine to overrev will not be executed
- ▷ During a stop the gearbox is automatically downshifted into the first gear so that, e.g. before a traffic light, it is only necessary to accelerate to continue driving
- ▷ When the speed is reduced, the gearbox is automatically downshifted shortly before a gear-dependent minimum speed is reached without you taking any action.

A – Automated mode

Each time the engine is started, the automated mode is activated as soon as you move the selector lever into the forward driving position.

In the automated mode all forward gears are automatically shifted.

Changeover from sequential to automated mode: tap the selector lever to the right toward "A." Watch the display in the instrument cluster, refer to page 61.

For rapid acceleration, e.g. during passing, depress the accelerator pedal completely (kick-down). The gearbox now downshifts in dependence on the selected driving program.

Even in the automated mode, you can help specify the shifting point: if a gear-dependent minimum speed is exceeded, you can upshift by slowly reducing pressure on the accelerator pedal. In the process, the respective driving situation is detected by sensors and taken into account.



Drivelogic

Drivelogic makes various driving programs available to you.

Press Drivelogic repeatedly until the desired driving program is shown in the SMG display of the instrument cluster, refer to page 61.

In the automated mode you can select from five driving programs ranging from convenience mode/winter operation to sporty and highly dynamic.

In the first automated driving program, starting off takes place in second gear, which is advisable under winter road conditions with ice and snow.

In the sequential mode you can choose from six driving programs ranging from balanced, dynamic to sporty, puristic driving. The sporty, puristic driving program can only be activated with the Dynamic Stability Control (DSC) deactivated, refer to page 76.

 To maintain vehicle stability, always drive with the DSC activated on whenever possible. ◀

Following each change between the sequential and the automated mode, the last driving program selected in the respective mode is active.

Exception: instead of the last selected sequential driving program 6, program 5 is activated only after the engine has been started again.

 Your vehicle is set so that when the engine is started, the last selected driving program saved in your key is activated for each shifting mode. ◀

Gradient assistance

The gradient assistance enables starting off on grades with virtually no roll-back. It can be activated in the sequential and automated mode with the vehicle stopped and can be used for both forward and reverse driving.

1. Depress footbrake with vehicle stopped
2. Activate the gradient assistance by pulling the left paddle for at least 0.5 seconds. An increase in the engine speed indicates that the gradient assistance is activated.

 Pulling the left paddle again briefly deactivates the gradient assistance again. ◀

3. Release the footbrake and start off within 2 seconds.

64 Sequential M gearbox* SMG II

 The vehicle may roll slightly before it is held by the gradient assistance after releasing the footbrake. Two seconds after the footbrake is released, the vehicle begins to roll, as it is no longer held with the gradient assistance. ◀

The gradient assistance must be reactivated before each use.

Indicator lamp



The transmission indicator lamp in the instrument cluster goes out after the engine is started.

- ▷ If it does not go out, or if it lights up during driving, a fault has occurred. The available functions may be limited under certain circumstances. Drive carefully and with the Dynamic Stability Control (DSC) activated. Have the system checked by the nearest BMW center
- ▷ If the indicator lamp flashes while driving, the system is overloaded. Avoid high loads until the indicator lamp goes out again permanently.



Shift lights

To achieve the best possible vehicle acceleration with a sporty driving style in the sequential mode, shift lights in the instrument cluster indicate the optimum shifting point shortly before the maximum engine speed is reached.

- 1 When the maximum engine speed is approached, yellow indicator fields (shift lights) in the tachometer light up consecutively to indicate the approaching upshift time
- 2 Shift at the latest when the last indicator field lights up red.

Tire replacement, snow chains

Following a tire or wheel change and after mounting or removing snow chains, the slip recognition of the

Sequential M gearbox* SMG II

SMG II must "become familiar" with the changed condition.

Reinitialize the system afterwards:

1. Move the selector lever into position 0 on a straight stretch of road at a speed of over 20 mph (30 km/h)
2. Pull both shift paddles for approx. 2 seconds.

If you do not carry out the initialization, the system automatically "learns" the changed condition gradually during driving. This can become apparent due to brief opening and closing of the clutch.

Indicator/Headlamp flasher 65



- 1 High beams (blue indicator lamp)
- 2 Headlamp flasher (blue indicator lamp)
- 3 Turn signal indicator (green indicator lamp accompanied by periodic clicking sound from the relay)

To signal briefly

Press the lever up to but not beyond the resistance point. It then returns to the center position when released.

 If the indicator lamp of the turn signal indicators and the clicking from the relay are both faster than normal, one of the turn signal indicators has failed. ◀



- 0 Wipers retracted
- 1 Intermittent operation or rain sensor
- 2 Normal wipe speed
- 3 Fast wipe speed
- 4 Brief wipe
- 5 Rotary dial for control of the wipe interval or the sensitivity of the rain sensor

Intermittent operation

(not on vehicles with rain sensor)

You can set the wipe interval at four stages with rotary dial 5. In addition, the wipe interval is varied automatically depending on road speed.

Rain sensor

The rain sensor is located on the windshield directly behind the rearview mirror.

To activate the rain sensor:

- ▷ With the ignition key in position 1 or higher, move the lever to position 1. The wipers will make at least one sweep across the windshield
- ▷ You can leave the lever in position 1 at all times. With the ignition key in position 1 or higher, all you then need to do to activate the rain sensor is briefly turn the rotary dial 5.

To adjust the sensitivity of the rain sensor: turn rotary dial 5.

To deactivate the rain sensor: return lever to position 0.



Deactivate the rain sensor in automatic car washes. Failure to do so could result in damage caused by undesired wiper activation. ◀

Normal wiper speed

When the vehicle is stationary, the wipers switch automatically to intermittent wipe (not on vehicles with rain sensor).

Fast wiper speed

When the vehicle is stationary, the wipers operate at normal speed (not on vehicles with rain sensor).



- 0 Wipers retracted
- 1 Clean the windshield

Cleaning the windshield

The system sprays washer fluid against the windshield and activates the wipers for a brief period.



Do not use the washers if there is any danger that the fluid will freeze on the windshield. If you do so, your vision could be obscured. For this reason, use an antifreeze agent, refer to page 109.

Do not use the washers when the reservoir is empty. This could cause damage to the washer pump. ◀

Cleaning the headlamps*

When the vehicle's lighting system is switched on, the headlamps will also be cleaned every fifth time the automatic windshield washer is activated.

Windshield washer jets

The windshield washer jets are warmed automatically when the ignition key is in position 2.

You can store and automatically maintain any desired vehicle speed above approx. 20 mph (30 km/h).

The cruise control is available whenever the engine is running and the system has been activated.

To activate the system



From ignition key position 2: Press the button and the indicator lamp in the instrument cluster (refer to page 20) will come on. You can now use the cruise control.



Do not use cruise control on twisting roads, when high traffic density prevents driving at a constant speed, when the road surface is slick (snow, rain, ice), or when the road surface is loose (rocks or gravel, sand). ◀

To deactivate the system



Press the button as often as you need to until the indicator lamp in the instrument cluster goes out.

Cruise control is also deactivated when the ignition key is in position 0.

The speed stored in memory is deleted.

To maintain and store speed or to accelerate



Press button (+) briefly: The system maintains and stores the current vehicle speed. Every time you tap the button, the speed increases by 0.6 mph (1 km/h).

Press and hold button (+): The vehicle accelerates without pressure on the accelerator pedal. When you release the button, the system maintains and stores the current speed.



If, on a downhill gradient, the engine's braking effect is not sufficient, the controlled speed can be exceeded. Speed can drop on uphill grades if the engine output is insufficient. ◀

Cruise control

To decelerate



Press button (-) briefly:

When cruise control is active, every tap of the button reduces the speed by approx. 0.6 mph (1 km/h).

Press and hold button (-):

With the cruise control active, the system automatically reduces the throttle opening to slow the vehicle. When you release the button, the system maintains and stores the current speed.

To interrupt the cruise control



When the system is activated, press the button. The indicator lamp stays on. You can use the cruise control again whenever you want by calling up the speed that was stored last.

In addition, cruise control is interrupted automatically:

- ▷ When the brakes are applied
- ▷ When pressing down the clutch pedal
- ▷ If you exceed or fall below the programmed speed for an extended period (by depressing the accelerator, for example)
- ▷ When shifting in the sequential mode, refer to sequential M gearbox* SMG II on page [59](#).

To recall the stored speed



Press button:

The vehicle accelerates to and maintains the last speed stored.



- 1 Odometer
- 2 Trip odometer

Odometer

You can activate the displays shown in the illustration with the ignition key in position 0 by pressing the button in the instrument cluster (arrow).

Trip odometer

To reset the trip odometer to zero, press the button (arrow) with the ignition key in position 1 or higher.



Variable pre-warning zone

The yellow pre-warning zone displays current permissible engine speed, depending on the engine temperature. As the engine temperature climbs, some of the sectors for this pre-warning zone will go out one after the other.

Avoid engine speeds in the pre-warning zone if possible.

Absolutely avoid engine speeds in the red warning zone.

To protect the engine, the fuel supply is interrupted when you approach this sector.



The general operating temperature is between 175 °F (80 °C) and 250 °F (120 °C). During performance-oriented driving, do not exceed the maximum temperature of 300 °F (150 °C).

Fuel gauge



Once the indicator lamp stays on continuously, there are still approx. 2 gallons (8 liters) of fuel in the fuel tank.

Fuel tank capacity: approx. 16.6 gal. (63 liters).

If the tilt of the vehicle varies (when you are driving in mountainous areas, for example), the needle may fluctuate slightly.



Please refuel early, since driving to the last drop of fuel can result in damage to the engine and/or catalytic converter. ◀

When you switch on the ignition, the indicator lamp lights up briefly as a functional check.

Temperature gauge



Blue

The engine is still cold. Drive at moderate engine and vehicle speeds.

Red

When you switch on the ignition, the warning lamp comes on briefly to confirm that the system is operational. If the lamp comes on while operating the vehicle, the engine has overheated. Switch off the engine immediately and allow it to cool down.

Checking coolant level, refer to page [112](#).

Between the blue and red zones

Normal operating range. The needle may rise as far as the edge of the red sector in normal operation.

Service Interval Display 71



Remaining distance for service

The displays shown in the illustration appear for a few seconds when the ignition key is in position 1 or after the engine is started.

The next service due appears with the message OILSERVICE or INSPECTION, together with the distance remaining before the next scheduled service. The computer bases its calculations of the remaining distance on the preceding driving style.

A flashing message and a "-" in front of the number mean that the service interval has already been exceeded by the distance shown on the display. Please contact your BMW center for an appointment.

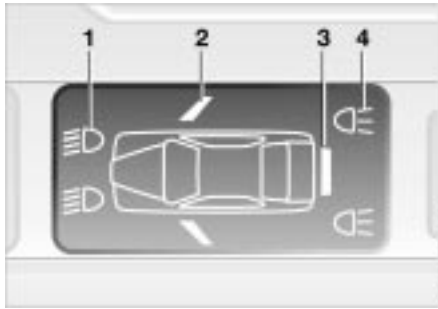

Display

The following information or conditions are displayed from ignition key position 2 on, until the cause has been corrected:

- 1 Inspect the low beams and the high beams, as well as the parking lamps
- 2 Door open
- 3 Luggage compartment lid open
- 4 Check brake and tail lamps.

After completion of a trip and upon opening the driver's door, an acoustic signal will sound yet not be displayed, as a reminder that the low beam headlamps have not been turned off.



Mode selection

With the ignition key in position 1 and higher, you can use the button in the turn signal lever to retrieve information from the computer for display in the instrument cluster. By pressing the button briefly in the direction of the steering column, you can call up a new function for display.

The displays appear in the following order:

Time of day, outside temperature, average fuel consumption, cruising range, average vehicle speed.

From ignition key position 1, the last active setting is displayed.

Clock

If you wish to have a permanent time display, you can make this adjustment in the car radio display (refer to the Radio Owner's Manual).

You can set the time of day, and the display for the car radio, as follows:



Adjustments

From ignition key position 1 the time of day appears in the display.

To set ahead: turn the knob to the right.

To set back: turn the knob to the left.

The adjustment speed will increase the longer you continue to hold the knob.

To change the display mode: press the knob briefly. Every time you press the knob, the clock display alternates between the 12-hour or 24-hour mode.

In ignition key position 0: the time is displayed for a few seconds after you press the left knob (refer to "Odometer", page 70).



Outside temperature

You can change the units of measure (°C/°F) for the outside temperature display by pressing the right-hand reset knob in the instrument cluster while the temperature display is active.

Ice warning

If the outside temperature drops to about 37.5 °F (+3 °C), then the computer will automatically switch to show the outside temperature. In addition, a signal sounds as a warning and the display flashes for a brief period.

 The ice warning does not alter the fact that surface ice can form at temperatures above 37.5 °F (+3 °C), on bridges or shaded road surfaces, for instance. ◀



Average fuel consumption

If you continue to hold the button on the turn signal lever, the average fuel consumption last displayed is recalculated from that point.

Range

The computer bases its calculations of the cruising range on the preceding driving style.

Average speed

If you continue to hold the button on the turn signal lever, the average fuel consumption last displayed for that speed is recalculated from that point in time.

Any time spent when the vehicle is stationary and the engine is shut off is ignored for the calculation.

Park Distance Control (PDC)*

The concept

PDC provides extra safety and convenience during parking maneuvers by providing an acoustic signal to indicate the distance to an object. To do this, four ultrasonic sensors in the rear bumper measure the distance to the nearest object. The monitoring range for the two rear sensors extends outward roughly 2 ft (60 cm). The range for the two center sensors is approx. 4.9 ft (1.50 m) wide.

The system starts to operate automatically about one second after you select reverse with the ignition key in position 2. PDC is deactivated when you shift back out of reverse.

Acoustic signals

The distance to the nearest object is indicated by a tone sounding at various intervals. As the distance between vehicle and object decreases, the intervals between the tones become shorter. A continuous tone indicates the presence of an object less than 1 ft (30 cm) away.

The warning signal is canceled after approx. three seconds if the distance to the obstacle remains constant during this time (if you are moving parallel to a wall, for instance).

System malfunctions will be indicated by a continuous high-pitched tone when the system is activated the first time. Please have your BMW center resolve the problem.



The PDC does not remove the driver's personal responsibility for evaluating the distance between the vehicle and any obstacles. Even when sensors are involved, there is a blind spot in which objects cannot be detected. This applies especially in those cases where the system approaches the physical limits of ultrasonic measurement, as occurs with tow bars and trailer couplings, and in the vicinity of thin or wedge-shaped objects.

Certain sources of sound, such as a loud radio, could drown the PDC signal tone. ◀



Keep the sensors clean and free of ice or snow in order to ensure that they continue to operate effectively.

Do not apply high pressure spray to the sensors for a prolonged period of time. Always maintain a distance of more than 4 in (10 cm). ◀

76 Dynamic Stability Control (DSC)

The concept

DSC maintains vehicle stability, even in critical driving situations.

The system optimizes vehicle stability during acceleration and when starting from a full stop, as well as optimizing traction. In addition, it also recognizes unstable driving conditions such as under- or oversteering on curves, and helps the vehicle remain on a steady course by using the engine and brake system to intervene at the different wheels – doing only what it can within the laws of physics, of course.

The DSC is operational every time you start the engine.



The laws of physics cannot be repealed, even with DSC. The results of driving irresponsibly rest with the driver. We therefore urge you to avoid using the additional safety margin of the system as an excuse for taking risks.

Do not make any modifications to the DSC system. Allow only authorized technicians to perform service procedures on the DSC. ◀

At first, you may need some time to become accustomed to this system's intervention. However, it guarantees optimum drive force and at the same time, the best possible vehicle stability.

Indicator lamp



The indicator lamp in the instrument cluster will go out shortly after the ignition has been switched on, refer to pages [18](#), [19](#).

- ▷ Indicator lamp flashes: the DSC is active and is controlling the drive torque based on driving conditions
- ▷ If the indicator lamp fails to go out after the engine has been started, or if it comes on during normal driving and stays on: the DSC has been deactivated via the button or there is a malfunction. You can continue to drive the vehicle normally, but without DSC. Please consult your BMW center for repairs.



To deactivate DSC

Press the DSC button briefly; the indicator lamp will light up and stay on.

The vehicle does not execute the stability-enhancement and traction-control functions when DSC is deactivated.

We recommend that you deactivate DSC for increased traction:

- ▷ When rocking the vehicle or starting off in deep snow or on loose surfaces
- ▷ When driving with snow chains.

 To maintain vehicle stability, always drive with the DSC activated on whenever possible. ◀

Reactivating the DSC

Press the button again; the indicator lamp goes out.

Dynamic Brake Control (DBC)

DBC is an integral component of the DSC system.

If you apply the brakes rapidly, this system automatically generates maximum braking force boost and thus helps to achieve the shortest possible braking distance in "panic braking" situations. All of the benefits of the ABS system are exploited under these circumstances.

Do not reduce the pressure on the brake pedal for the duration of the brake application. When the brake pedal is released, the DBC is deactivated.

The concept

As you drive, the Flat Tire Monitor keeps track of pressure levels in all four tires in order to detect and warn of any substantial pressure loss.

The system actually detects pressure loss by monitoring differences in the relative speeds of the four wheels. It interprets variations outside specified limits as severe pressure loss, and then responds by generating a warning.



3. Press button as long as you need to until the indicator lamp in the instrument cluster lights up. After a little while, the indicator lamp will go out by itself
4. After a few minutes, the Flat Tire Monitor will accept the current inflation pressure as the value to be measured against, and from that point on, can detect and report a flat tire.



Initializing the system

Initializing is necessary to familiarize the system with the correct tire inflation pressure.

Repeat this process after any changes in tire inflation pressure, tire replacement or rotation.

1. Check the tire inflation pressure in all the tires, comparing them with the inflation pressure table (page 25), and adjusting their pressure if necessary
2. Turn the ignition key to position 2

Activating/deactivating the system

The system is automatically activated in ignition key position 2 and consequently is on whenever the vehicle is operated.

To deactivate the system, tap the button, the indicator lamp will light up yellow.

To activate the system, tap the button again; the indicator lamp goes out.

Deactivate the system when snow chains are mounted, since false warnings and undetected losses in pressure are possible under these kinds of conditions.

Flat Tire Monitor

In the event of a flat tire



The indicator lamp in the instrument cluster will light up red in the event of a flat tire with ensuing loss in pressure. In addition, an acoustic signal is sounded. To come to an immediate stop, reduce speed, while avoiding any sudden, jerky braking or steering maneuvers.

Fix the flat tire using the M Mobility system, refer to page 126.

Reset the indicator lamp: the red indicator lamp has to be switched off manually after putting on a new wheel. At this point, hold the Flat Tire Monitor button down until the indicator lamp goes out. Reinitialize the system afterward.

 The Flat Tire Monitor cannot alert you to severe and sudden tire damage caused by external factors. Another factor which the Flat Tire Monitor does not recognize is the balanced and very gradual pressure loss that takes place in all tires over an extended period of time. ◀



Check the tire inflation pressure on a regular basis and correct if necessary, refer to page 24.

Under certain circumstances, there may be false warnings or a delayed detection of losses in pressure when driving on snow-covered or slippery road surfaces.

Performance-oriented driving (slip at the drive wheels, high levels of lateral acceleration) can also delay the appearance of status reports in the Flat Tire Monitor's display. ◀

System malfunction

As long as there is still a malfunction, the indicator lamp in the instrument cluster will stay lit up yellow.

Please contact your BMW center for additional information.

M Engine dynamics control 79



The system (sport-mode identification) will cause the engine to respond spontaneously to the motion of the accelerator pedal.

Activating/deactivating sport-mode identification

Activating: with the key in ignition key position 2, press the sport button. The indicator lamp will light up.

 The vehicle may gain speed without any additional pressure on the accelerator pedal when the system is activated. ◀

Deactivating: press the sport button again; the indicator lamp will go out.

The sporty-comfortable mode is deactivated every time the engine is started.



Parking lamps



With the switch in this position, the front, rear and side vehicle lighting comes on. You can use the parking lamps for parking. Refer to page 81 for one-sided lighting as an additional possibility for parking.

Low beams



When you switch the ignition off with the low-beam headlamps on, only the parking lamps will remain on.



"Follow me home":

When you activate the headlamp flasher after parking the vehicle and switching off the lamps, the low beams will come on for a brief period. You can also have this function deactivated. ◀

LIGHTS ON warning

Whenever you open the driver's door, after having turned the ignition key to position 0, you will hear an acoustic signal for a few seconds to remind you that the lamps have not been switched off.

Daytime driving lamps*

The headlamps are automatically switched on for daytime driving at ignition key position 2.

Automatic headlamp control*



When the switch is in this position the system automatically responds to changes in ambient light (in tunnels, at dusk, etc.) as well as rain and snow by switching the low beams on or off. ◀



The headlamps and other external lamps remain on when you switch on the fog lamps manually while the headlamps are on following automatic activation. ◀



Automatic headlamp control cannot serve as a substitute for your personal judgement in determining when the lamps should be switched on. The sensors are not able to detect fog, for example. When these kinds of low-visibility situations arise you should switch on the lamps manually to ensure continued safety. ◀



You can have the sensitivity of your vehicle's automatic headlamp control adjusted. ◀

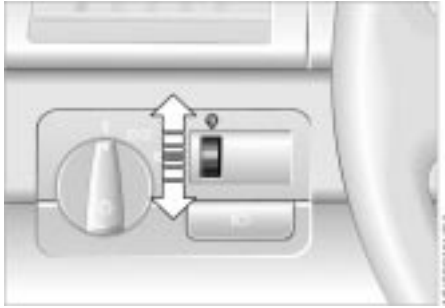

Turn the rotary dial to control the lighting when the parking or low-beam headlamps are on.



- 1 High beams (blue indicator lamp)
- 2 Headlamp flasher (blue indicator lamp)
- 3 Standing lamps

Standing lamps, left or right*

As an additional feature, you can illuminate your vehicle on either side for parking, if you wish to do so:

With the ignition key in position 0, engage the lever in the appropriate turn-signal position.



Front fog lamps

 The green indicator lamp in the instrument cluster lights up to indicate that the front fog lamps are on.

 If the automatic headlamp control is on, the low beams will come on automatically whenever you switch on the fog lamps. ◀

Interior lamps



The interior lamps operate automatically.

Switching the interior lamps on and off manually

Press button 1 briefly.

If you want the interior lamps to remain off all the times, press and hold the button for approx. 3 seconds.

Press the button briefly to revert to normal operation.

Front reading lamps

Switch on and off with button 2 adjacent to each lamp.

Reading lamps



Rear reading lamps

Switch on and off with the button adjacent to each lamp.

 To avoid subjecting the battery to excessive loads, all of the lamps within the vehicle are automatically switched off approx. 15 minutes after you turn the ignition key to position 0. ◀

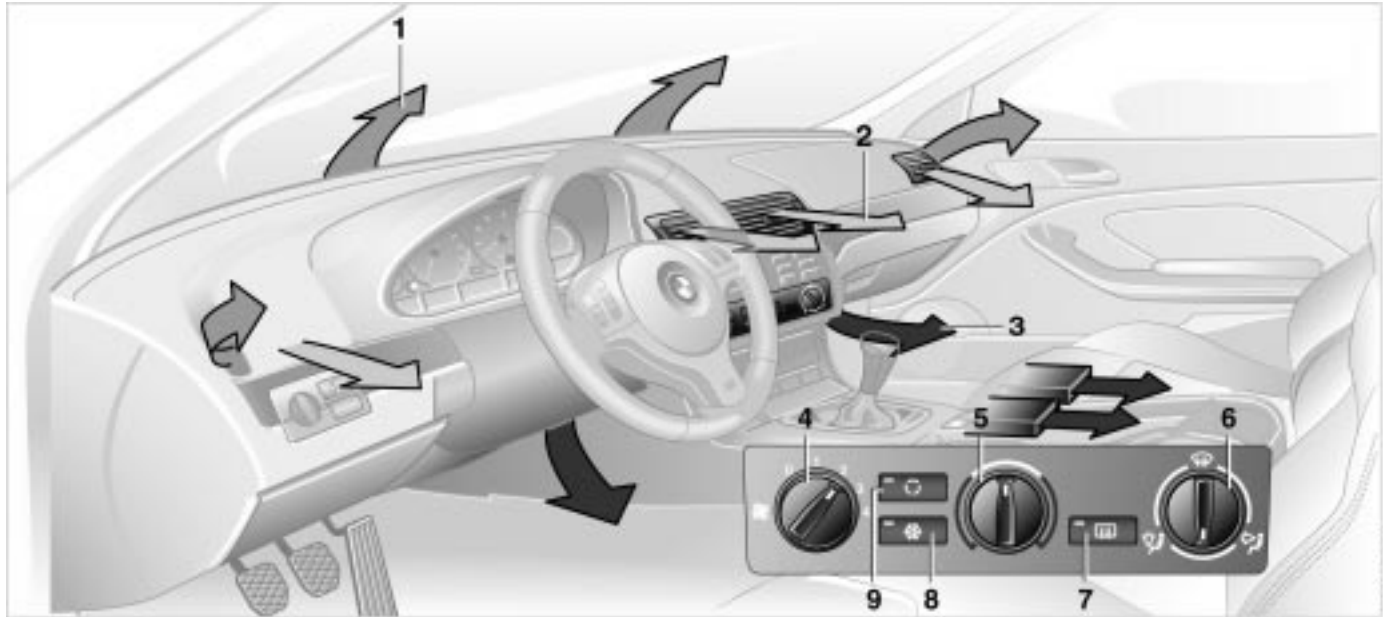

1 Air onto the windshield and onto the side windows
2 Airflow for the upper body area [85](#)
3 Front footwell ventilation

4 Air supply (blower) [84](#)
5 Temperature [84](#)
6 Air distribution [84](#)

7 Rear window defroster [84](#)
8 Air conditioner [84](#)
9 Recirculated-air mode [84](#)





Air supply (blower)

You can select blower speeds from 1 to 4. The heating and ventilation become more and more effective as the air supply settings are increased. In position 0, the blower and the heater are switched off. By using position 0, you can totally block the air supply by pressing the button for the recirculated-air mode.

Temperature

In order to increase the temperature of the passenger compartment, turn it to the right (red). Temperature regulation will keep the interior temperature you have selected constant.

Air distribution

You can direct air to flow onto the windows , toward the upper body  and into the footwell . All intermediate settings are possible. In the  setting, there is a low flow of air onto the windows to keep them free of condensation.

Rear window defroster

When the rear window defroster is activated, the indicator lamp comes on. The rear window defroster switches off automatically.



The rear window defroster automatically assumes operation within 5 minutes after the engine is started at outside temperatures below 40 °F (4 °C). ◀

Air conditioner

The air is cooled and dehumidified and – depending on the temperature setting – warmed again when the air conditioner system is switched on.

Depending on the weather, the windshield may fog over briefly when the engine is started.



Condensation forms in the air conditioner system during operation, which then exits under the vehicle. Traces of condensed water of this kind are thus normal. ◀

Recirculated-air mode

You can respond to unpleasant external odors by temporarily excluding the supply of outside air. The system then recirculates the air currently within the vehicle.



If the windows fog over in the recirculated-air mode, switch the recirculated-air mode off and increase the air supply as required. ◀

Air conditioner

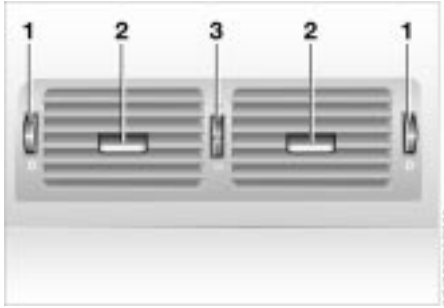

Draft-free ventilation

You can adjust the blower controls for the upper body area to select the optimum airflow rates and directions for your personal requirements:

- 1 Rotary dials for opening and closing the vent outlets through an infinitely variable range
- 2 Lever for adjusting airflow direction
- 3 With the rotary dial you can adjust the temperature of the outgoing air:
 - ▷ Turn toward blue – colder
 - ▷ Turn toward red – warmer.

Microfilter

A microfilter, which traps incoming dust and pollen, has been installed in your vehicle. Your BMW center will replace it during routine maintenance. A substantial reduction in airflow indicates that the filter needs to be replaced early.



To defrost windows and remove condensation

1. Set the blower speed control for the air supply rate to position 4
2. Turn the rotary temperature control completely to the right (red)
3. Rotary control for air distribution in position 
4. Switch on the rear window defroster to defrost the rear window.

86 Automatic climate control*

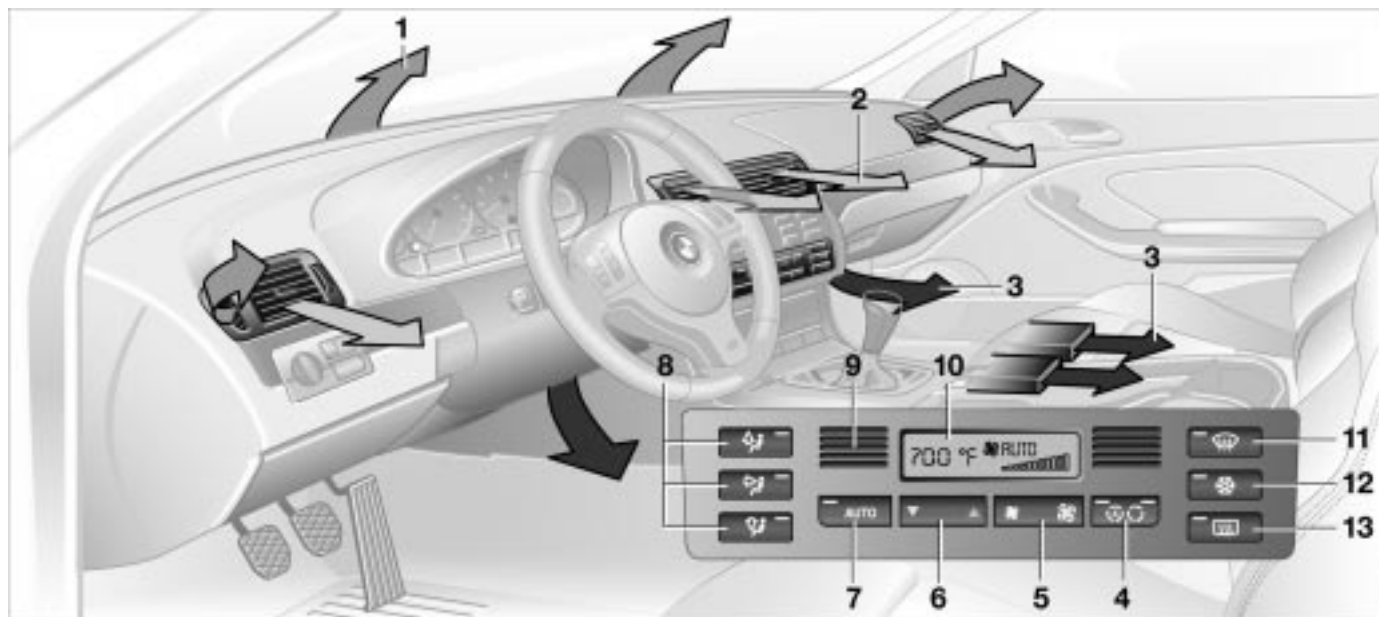

1 Air onto the windshield and onto the side windows

2 Airflow toward the upper body [88](#)

3 Front footwell ventilation

4 Recirculated-air mode/Automatic recirculated air control (AUC) [88](#)

5 Air supply (blower) [87](#)

6 Temperature [87](#)

7 Automatic air distribution [87](#)

8 Individual air distribution [87](#)

9 Interior temperature sensor – please keep clear and unobstructed

10 Display for temperature and air supply [87](#)

11 To defrost windshield and side windows [87](#)

12 Air conditioner [88](#)

13 Rear window defroster [88](#)

Tips for pleasant driving

Use the automatic system (switch on AUTO button 7). Select the desired interior temperature.

Detailed setting options are described for you in the following sections.



Your vehicle is set in such a manner that, when you unlock the vehicle with the remote control of your personal key, your own personalized setting for the automatic climate control is initiated. ◀

Automatic air distribution



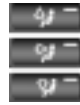

The AUTO program assumes the adjustment of the air distribution and the air supply for you and – in addition to that – adapts the temperature to external influences (summer, winter) to meet preferences you can specify.

Individual air distribution



You can cancel the AUTO program by selecting specific distribution patterns to suit your own individual requirements.

While the AUTO program is then deactivated, the automatic air supply control remains in operation. The system directs air to the windows , the upper body  and into the footwells . You can reactivate the automatic air supply by pressing the AUTO button.

Temperature



The displayed temperatures are reference values for the interior temperature. We recommend 72°F (+22°C) as a comfortable setting, even if the air conditioner is on. When you start the vehicle, the system ensures that the selected temperature is reached as quickly as possible. It then maintains this temperature, regardless of the season.

Air supply (blower)



By pressing the left or right side of the button, you can vary the air supply. This deactivates the automatic air supply – the AUTO display disappears from the panel. Nevertheless, the automatic air distribution remains unchanged. You can reactivate the automatic air supply by pressing the AUTO button.

When you set the lowest blower speed by pressing the left half of the button, all of the displays are canceled: the blower, heating and air conditioner are switched off, and the air supply is stopped. You can reactivate the system by pressing any button for the automatic climate control.

To defrost windows and remove condensation



This program quickly removes ice and condensation from the windshield and side windows.

Air conditioner

 The air is cooled and dehumidified and – depending on the temperature setting – rewarmed when the air conditioner system is switched on. Depending on the weather, the windshield may fog over briefly when the engine is started. Window mist will be reduced by switching on the air conditioner.

 Condensation forms in the air conditioning system during operation, which then exits under the vehicle. Traces of condensed water of this kind are thus normal. ◀

Automatic recirculated-air control (AUC)

 If there are unpleasant odors or pollutants in the outside air, you can temporarily block the air supply from the outside. The system then recirculates the air currently within the vehicle. By repeatedly pressing the button, you can select one of three different operating modes.

- ▷ Indicator lamps off: outside air always flowing into the vehicle
- ▷ Left-hand indicator lamp on – automatic mode: the system detects

pollutants in the outside air and responds by deactivating the outside air supply as required. The system then recirculates the air currently within the vehicle

Depending on air quality requirements, the system automatically switches between outside air supply and recirculation of the air already within the vehicle

- ▷ Right-hand indicator lamp on: the air supply of outside air is permanently blocked. The system recirculates the air already within the vehicle.

 If the windows fog over in the recirculated-air mode, switch the recirculated-air mode off and increase the air supply as required. ◀

Rear window defroster

 When the rear window defroster is activated, the indicator lamp comes on. The rear window defroster switches off automatically.

 The rear window defroster automatically assumes operation within 5 minutes after the engine is started at outside temperatures below 40 °F (4 °C). ◀

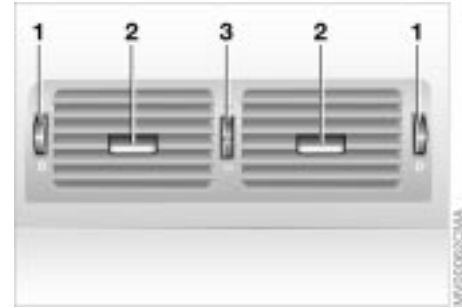
**Draft-free ventilation**

You can adjust the blower controls for the upper body area to select the optimum airflow rates and directions for your personal requirements:

- 1 Rotary dials for infinitely-variable opening and closing of the vents
- 2 Selector lever for airflow direction
- 3 With the rotary dial you can adjust the temperature of the outgoing air:
 - ▷ Turn toward blue – colder
 - ▷ Turn toward red – warmer.

Microfilter, activated-charcoal filter

The built-in microfilter removes dust and pollen from the incoming air. The activated-charcoal filter provides additional protection by filtering gaseous pollutants from the outside air. Your BMW center will replace the combined filter as a standard part of your scheduled maintenance. A substantial reduction in air supply indicates that the filter needs to be replaced early.



To actuate, press the button briefly with ignition key in position 1 or higher.



Sound system – harman kardon

Special acoustical effects are activated or deactivated every time you press the button.

When the system is activated, the impression of a significantly larger passenger compartment is created at all seating areas, together with an improvement of the stereo effect.

The system responds to poor reception conditions by repeatedly alternating between the stereo and monophonic modes. You should then switch the system off.

Glove compartment

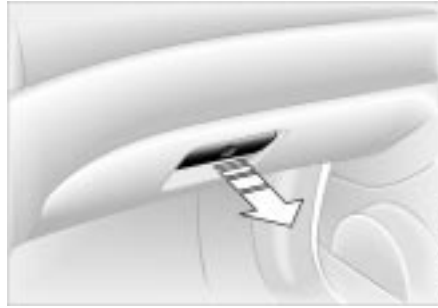

 If you turn over only your door and ignition key for valet parking, for example (refer to page 28), access to the glove compartment is not possible. ◀

To open

Pull the handle. The glove compartment lamp will light up.

To close

Fold up cover.

 To prevent injury in the event of a crash, close the glove compartment immediately after use. ◀

To lock

Use one of the master keys. A master key can also be used for unlocking.



Front center armrest*

To release: press the button (arrow) and lift upward.

Other compartments and nets

You will find additional storage areas in the doors and in the center console above the ashtray. Storage nets are located on the backrests of the front seats.



Beverage holder, coin box

Two beverage holders and a coin box are provided in the center console.

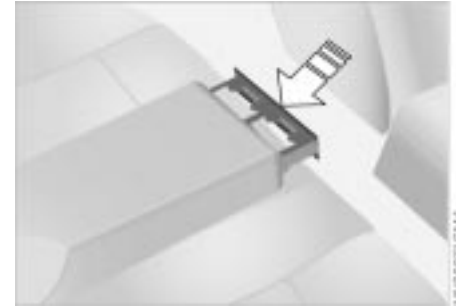

Rear center armrest*

You will find a beverage holder (for two drink containers) in the rear center armrest.

Opening the beverage holder: press (arrow).

92 Storage compartments



Storage package*

For your convenience, there are:

- ▷ Two flip-out sockets on the rear center console (arrows)
- ▷ An eyeglass storage compartment* in the front center console above the ashtray.

Cellular phone*



Hands-free system

On vehicles with telephone preparation* or a communications package*, the trim piece for the hands-free microphone is located in the headliner near the interior lamp.

For further information on the cellular phone, refer to the separate Owner's Manual.

Ashtray, front



To empty

Press on the edge of the open cover (arrow): the ashtray moves up and can be removed.

Extinguishing cigarettes

Tap off the ash and gently press the tip into the funnel.

Ashtray, front

Cigarette lighter

Press the lighter 1 in. Remove as soon as the lighter jumps back out.

 Hold or touch the hot cigarette lighter by the knob only. Holding or touching it in other areas could result in burns.

The cigarette lighter remains operational when the ignition key has been removed. For this reason, children should never be left in the vehicle unattended. ◀

Cigarette lighter socket

It can be used for attaching power supplies for flashlights, car vacuum cleaners and other similar appliances up to a rating of approx. 200 watts at 12 volts. Avoid damaging the socket due to inserting plugs of different shapes or sizes.

Ashtray, rear



To empty

Press on the edge of the raised cover in the opening direction (arrow): the ashtray moves up and can be removed.

Clothes hooks

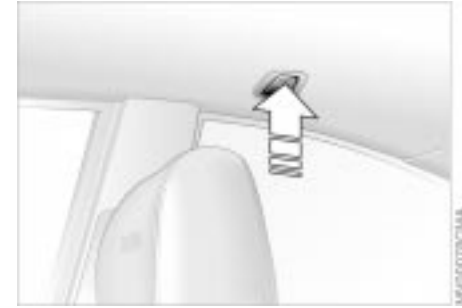

Press on the upper edge to fold it up. For additional information, refer to page [101](#).

 When suspending clothing from the hooks, be sure that they will not obstruct the driver's vision. Do not hang heavy objects on the hooks. If you do so, they could cause personal injury during braking or evasive maneuvers. ◀

94 Through-loading system

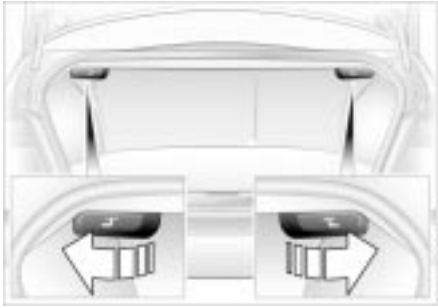

Folding the rear backrest down

1. To unlock, pull the lever corresponding to the section (arrow)



2. The rear backrest section will move forward slightly when it is unlocked. Reach into the gap and pull the backrest down.

 When folding the backrest back into its original position always ensure that the detent engages securely. A loose backrest might fail to prevent cargo from entering the passenger compartment during sudden braking or evasive maneuvers, posing a potential hazard to occupants. ◀



Center 3-point-safety belt in the rear*

You can retract the 3-point-safety belt in the rear, before folding the through-loading system back:

Retracting the 3-point-safety belt: Loosen the safety belt and insert the buckle latch into the support mount provided on the rear window shelf (arrow).

 Always use the outside safety belts to install child-restraint systems. Use the middle safety belt only if it is necessary to install three child-restraint systems. Do not modify the child-restraint system in any way. If you do so, it will not provide your child with maximum protection. ◀

Ski bag*

The ski bag allows the safe and clean transport of up to 4 pairs of standard skis or up to two snowboards.

The length of the ski bag and the additional space provided in the luggage compartment make it possible to carry skis up to 6.8 ft long (2.10 m). Because of the tapered shape of the ski bag, it can only accommodate two pairs of skis 6.8 ft long (2.10 m).

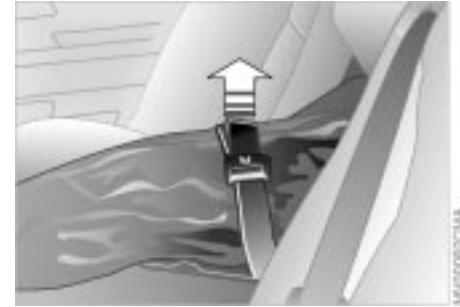

Loading

1. Fold the center armrest outward. Loosen the trim from the upper Velcro® fastener and place it on the armrest
2. Press button 1 downward and swing the cover forward
3. Extend the ski bag between the front seats. The zipper provides convenient access to stored items. It may be opened to allow the ski bag to dry
4. Press knob 2: the cover in the luggage compartment is unlocked.

To store the ski bag, perform the above steps in reverse sequence.

Securing the load

Secure the bag's contents by tightening down the retaining strap at the buckle.

 Please be sure that the skis are clean before loading them into the bag. Be careful to avoid damage from sharp edges. ◀

96 Cargo loading

 Always position and secure the load correctly. If you do not, it can endanger the passengers during braking or evasive maneuvers. Do not exceed the approved gross weight and the approved axle loads (refer to page 138), otherwise the vehicle's operating safety is no longer assured and you are in violation of the law.

Do not stow heavy or hard objects in the passenger compartment without first securing them. Otherwise they would be thrown around during braking and evasive maneuvers and endanger the passengers. ◀

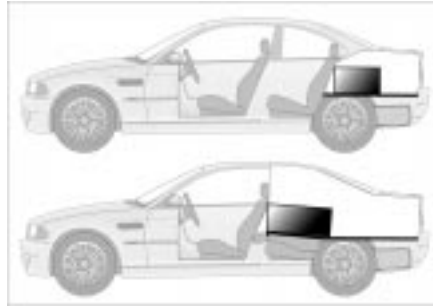

Stowing cargo

If you are transporting a load in your BMW:

- ▷ Load heavy cargo as far forward as possible – directly behind the backrests or the luggage compartment partition – and as low as possible
- ▷ Cover sharp edges and corners
- ▷ Do not pile objects higher than the top edge of the backrest

- ▷ For very heavy loads when the rear seat is not occupied, secure each safety belt in the opposite buckle (refer to illustration).

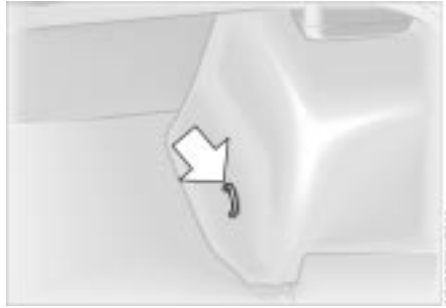

Securing the cargo in the luggage compartment

- ▷ For small, light items, use the rubber-lined non-skid side of the floor mat or secure with a luggage compartment net* or elastic straps, refer to page 36
- ▷ For large, heavy pieces, see your BMW center for load-securing devices*. Lashing eyes (arrow) are provided at the inner corners of the luggage compartment for attaching these load-securing devices.

Read and comply with the information enclosed with the load-securing devices.



A special luggage system is available as an option for your BMW. Please observe the precautions included with the installation instructions.

Anchors

Access to the anchors:

To fold up the covers (arrow), please use the tool which is provided with the luggage system.

Loading and driving notes

Because roof racks raise the center of gravity of the vehicle when loaded, they exercise a major effect on its handling and steering response.

When loading, be sure to remember not to exceed the approved roof weight, the approved gross vehicle weight or the axle loads. You will find the specifications under "Technical Data" on page 138.

Make sure that the load is not too heavy, and attempt to distribute it evenly. Always load the heaviest pieces first (on the bottom). Be sure that adequate clearance is maintained for raising the sliding/tilt sunroof, and that objects do not project into the opening path of the luggage compartment lid.

 Secure the roof luggage correctly and securely to prevent it from shifting or being lost during driving (danger for following traffic). ◀

Drive smoothly and avoid sudden acceleration or braking. Do not corner at high speeds.



Overview

Controls and features

Operation, maintenance

Owner service procedures

Technical data

Index



Overview
Controls
Maintenance
Repairs
Data
Index

To ensure that your vehicle provides maximum economy throughout a long service life, we request that you observe the following instructions.



Because of its engineering design, the BMW M3 is an especially high-quality vehicle. It is in your best interest to follow the break-in instructions very closely. Doing this, you will create the basis for a long, optimum service life. ◀

Engine and differential

▷ Until a km reading of 1,200 miles (2,000 km): drive at varying engine and road speeds, but do not exceed the following rpms or road speeds: 5,500 rpm or 105 mph (170 km/h)

Obey your local and state maximum speed limits.

Do not depress the accelerator pedal to the full-throttle position.

Vehicles with SMG II* (refer to page 59): refrain from using driving program 6 in the sequential mode during the break-in period.

▷ After you have monitored the break-in period for 1,200 miles (2,000 km), you can begin to gradually increase both engine and road speed.

Please remember to observe the same break-in procedures if either the engine or the differential is replaced later in the course of the vehicle's service life.

Tires

Owing to technical factors associated with their manufacture, tires do not achieve their full traction potential until an initial break-in period has elapsed. Thus drive with extra care during the initial 200 miles (300 km).

Obey your local and state maximum speed limits.



When the vehicle is operated on wet or slushy roads, a wedge of water may form between the tire and the road surface. This phenomenon is referred to as aquaplaning, or hydroplaning, and can lead to partial or complete loss of traction, vehicle control and braking effectiveness. Reduce your speed on wet roads. ◀

Brake system

Approx. 300 miles (500 km) must elapse before the brake pads and rotors achieve the optimal pad-surface and wear patterns required for trouble-free operation and long service life later on.

To break-in the separate parking brake drums, apply the parking brake lightly when coasting to a standstill (at a traffic signal, for instance), provided that traffic conditions allow you to do so. To avoid corrosion, repeat this procedure from time to time.



The brake lamps do not come on when the parking brake is engaged.

Vacuum for the brake system servo unit on your BMW is available only when the engine is running. When you move the vehicle with the engine off – when towing, for example – substantially higher levels of pedal force will be required to brake the vehicle. ◀

Clutch

The clutch will also begin to function optimally after about 300 miles (500 km). Drive cautiously during this break-in period and do not shift at high engine speeds.



Brakes:

Do not drive with your foot resting on the brake pedal. Even light but consistent pedal pressure can lead to high temperatures, brake wear and possibly even brake failure.

Aquaplaning:

When driving on wet or slushy roads, reduce vehicle speed. If you do not, a wedge of water may form between the tires and the road surface. This phenomenon is referred to as aquaplaning, or hydroplaning, and can lead to partial or complete loss of traction, vehicle control and braking effectiveness.

Driving through water:

Do not drive through water on the road if it is deeper than 1 foot (30 cm), and then only at walking speed. Otherwise, the vehicle's engine, the electrical systems and the transmission may be damaged.

Rear parcel tray:

Never use it to store heavy or hard objects, otherwise, occupants could be injured if the vehicle is braked hard.

Clothes hooks:

When suspending clothing from the hooks, be sure that they will not obstruct the driver's vision. Do not hang heavy objects on the hooks. If you do so, they could cause personal injury during braking or evasive maneuvers. ◀

The concept

The Antilock Brake System (ABS) keeps the wheels from locking while braking, thereby enhancing active driving safety.

Braking with ABS

If you are in a situation that requires full braking, you will exploit the full benefits of the ABS system if you apply maximum brake pressure ("panic stop"). Since the vehicle maintains steering responsiveness, you can nevertheless avoid possible obstacles with a minimum of steering effort.

Pulsation at the brake pedal combines with sounds from the hydraulic circuits to indicate to the driver that ABS is in its active mode.

Cornering Brake Control (CBC)

CBC is an advanced engineering design of the ABS. When braking while cornering at high speed or braking during high lateral acceleration, or when braking during a lane change, vehicle stability is improved and steering response is enhanced.

Brake fluid level

Low brake fluid level in the reservoir combined with longer than usual pedal travel may indicate a defect in one of the brake system's hydraulic circuits.

 Proceed to the nearest BMW center. Higher brake application pressure may be necessary when stopping, and the vehicle may exhibit a slight tendency to pull to one side. Brake distances may even be longer. Please remember to adapt your driving style accordingly. ◀

Disc brakes

When the vehicle is driven only occasionally, during extended periods when the vehicle is not used at all, and in operating conditions where brake applications are less frequent, there is an increased tendency for corrosion of the rotors and accumulation of contamination on the brake pads. This occurs because the minimal pressure that must be exerted by the pads to clean the rotors by brake applications is not reached.

Corrosion on brake rotors is signaled by a pulsation during braking; even extended subsequent braking will not cure this phenomenon.

It is a good idea to periodically dry the brakes with a gentle brake application when driving in rain and on wet roads. Monitor traffic conditions to ensure that this maneuver does not endanger other road users. The heat generated in this process helps dry the pads and rotors to ensure that your brake system will respond with undiminished efficiency when you need it.

Extended or steep mountain descents should be driven in the gear in which only minimal periodic brake applications are required. This helps avoid placing excessive loads on the brake system. Stay within the allowable rpm range. For additional information, refer to page 70.

 Do not coast with the clutch depressed or with the gearshift lever in idle. Do not coast with the engine switched off. If you do so the engine provides no braking effect and there is no power assist for braking or steering when the engine is not running. ◀

Brake pads

 For your own safety: Use only brake pads which BMW has approved for your specific vehicle model. BMW cannot evaluate non-approved brake pads to determine if they are suited for use, and therefore cannot ensure the operating safety of the vehicle if they are installed. ◀

Tire inflation pressure

Information for your safety

The factory-approved radial tires are matched to the vehicle and have been selected to provide optimum safety and driving comfort on your vehicle.

It is not merely the tire's service life, but also driving comfort and – above all else – driving safety that depend on the condition of the tires and the maintenance of the specified tire pressure.

 Incorrect inflation pressures are a frequent cause of tire problems and tire damage. Tire pressure also has a major effect on your BMW's handling response. Check tire inflation pressures on a regular basis (refer to page 25), at least every two weeks and before beginning a longer trip. Failure to observe these precautions can result in incorrect tire pressures, which cause instable handling response as well as tire damage, and can ultimately lead to an accident. ◀

Tire condition



Tire tread – tire damage

Inspect your tires frequently for tread wear, signs of damage and for foreign objects lodged in the tread. Check the tread pattern depth.

Tread depth should not be allowed to go below 0.12 in (3 mm), even though the legally specified minimum tread depth is only 0.063 in (1.6 mm). Tread wear indicators (arrow) are embedded in the base of the tire's tread. Their locations are indicated by the legend "TWI" – Tread Wear Indicator – at various points on the tire's shoulder. When the tread reaches a depth of 0.063 in (1.6 mm), these indicators appear to signal that the tires have worn to the minimum legal level. Below 0.12 in (3 mm) tread depth, there is an increased risk of aquaplaning, even at

relatively moderate speeds and with only small amounts of water on the road.

 Do not drive on a deflated (flat) tire. A flat tire greatly impairs steering and braking response, and can lead to complete loss of control over the vehicle.

Avoid overloading the vehicle so that the permitted load on the tires is not exceeded. Overloading leads to overheating and causes damage inside the tires. You could have a blowout as a result.

Unusual vibrations encountered during normal vehicle operation can indicate tire failure or some other vehicle defect. The type of problem can be caused by contact with curbs, etc. This is also true for irregularities in the vehicle's handling characteristics, such as a pronounced tendency to pull to the left or right. Should this occur, respond by immediately reducing your speed. Proceed carefully to the nearest BMW center or professional tire center, or have the vehicle towed in to have it and its wheels and tires inspected. Tire damage (up to and including blowouts) can endanger the lives of both the vehicle occupants and other road users. ◀

DOT Quality Grades

Treadwear
Traction AA A B C
Temperature A B C

 All passenger vehicle tires must conform to Federal Safety Requirements in addition to these grades. ◀

Tread wear

The tread wear grade is a comparative rating based on the wear rate of the tire when tested under controlled conditions on a specified government test course.

For example, a tire graded 150 would wear one and one-half (1 ½) times as well on the government course as a tire graded 100. The relative performance of tires depends upon the actual conditions of their use, however, and may depart significantly from the norm due to variations in driving habits, service practices and differences in road characteristics and climate.

Traction

The traction grades, from highest to lowest, are AA, A, B, and C. Those grades represent the tire's ability to stop on wet pavement as measured under controlled conditions on specified government test surfaces of asphalt and concrete. A tire marked C may have poor traction performance.

 The traction grade assigned to this tire is based on straight-ahead braking traction tests, and does not include acceleration, cornering, hydroplaning, or peak traction characteristics. ◀

Temperature

The temperature grades are A (the highest), B, and C, representing the tire's resistance to the generation of heat and its ability to dissipate heat when tested under controlled conditions on a specified indoor laboratory test wheel. Sustained high temperature can cause the material of the tire to degenerate and reduce tire life, and excessive temperature can lead to sudden tire failure. The grade C corresponds to a level of performance which all passenger vehicle tires must meet

under the Federal Motor Vehicle Safety Standard No. 109. Grades B and A represent higher levels of performance on the laboratory test wheel than the minimum required by law.

 The temperature grade for this tire is established for a tire that is properly inflated and not overloaded. Excessive speed, underinflation, or excessive loading, either separately or in combination, can cause heat buildup and possible tire failure. ◀

Uniform Tire Quality Grading

Quality grades can be found where applicable on the tire sidewall between tread shoulder and maximum section width. For example:

Treadwear 200 Traction AA
Temperature A

Tire replacement

Tire age

BMW recommends the replacement of all tires after 6 years at the latest, even if a tire life of 10 years is possible.

The date on which the tire was manufactured is indicated by the code on the sidewall:

DOT ... 4101 means that the tire was produced in the 41st week of the year 2001.

Following wheel/tire changes

Following wheel and/or tire replacement you will need to reinitialize both the Flat Tire Monitor and the sequential M gearbox* SMG II, refer to pages [65](#), [78](#).

Wheel and tire combinations

The right choice



Use only wheels and tires approved by BMW for the corresponding vehicle model, as otherwise the tires may make contact with the body as the result of tolerances despite the same nominal size being used, resulting in serious accidents. If non-approved wheels and tires are used, BMW cannot evaluate their suitability, and therefore cannot be held liable for driving safety. ◀

BMW tests certain tire brands for each tire size, classifies them as road-safe and approves them. Consult your BMW center for more information. Observe any country-specific regulations, e.g. on making a corresponding entry in the vehicle documents.



The correct wheel and tire combination affects different systems such as ABS, DSC, Flat Tire Monitor. The function of these systems is impaired if improper wheel and tire combinations are used. For this reason, use only tires of the same brand and tread pattern on the vehicle and, for example, restore the approved wheel and tire combination following a flat tire as soon as possible. ◀



The use of rims and lug bolts that do not meet the specifications of the original factory-installed equipment will affect the safe operation of your vehicle and may cause an accident and personal injury.

Never mix tires of different design, such as steel-belted radials with radial bias-belted or bias-ply tires, etc. Mixing tire types will adversely affect roadholding and can lead to loss of vehicle control. ◀

Storage

Store tires in a cool, dry place, protecting them against light whenever possible. Protect the tires against contact with oil, grease and fuel.

Choosing the right tire

BMW recommends winter tires (M+S radial tires) for operation under adverse winter driving conditions. So-called all-season tires with the M+S identification mark do indeed possess better winter traction than summer tires that have the H, V, W, Y and ZR speed ratings, they generally fail to provide the same levels of performance as snow tires.

In the interest of safe tracking and steering response, install winter tires made by the same manufacturer having the same tread configuration on all four wheels.

Do not exceed specified maximum speeds

Never exceed the maximum speed for which winter tires are rated.

Unprofessional attempts by laymen to service tires can lead to damage and accidents.

Have this work performed by skilled professionals only. Any BMW center has the required technical knowledge and the proper equipment and will be happy to assist you. ◀

Tire condition, tire pressure

Once winter tires wear to a tread depth of less than 0.16 in (4 mm), their performance under winter driving conditions deteriorates noticeably. Worn tires should therefore be replaced for safety considerations.

Inflate tires to specified pressure and have the wheels balanced every time the tires or wheels have been replaced.

Snow chains

Use narrow-link BMW snow chains* on winter tires in pairs only and only on the rear wheels. Comply with all manufacturer's safety precautions when mounting the chains. Do not exceed a maximum speed of 30 mph (50 km/h) with snow chains.

After mounting or removing snow chains, always reinitialize the sequential M gearbox* SMG II, refer to page 65.



It is not possible to mount snow chains on tires with 18- and 19-inch wheels.

Deactivate the Flat Tire Monitor when using snow chains. Malfunction warnings and undetected losses in pressure are a possibility when driving with snow chains.

For additional information, refer to page 77. ◀



To release

Pull the lever located under the left-hand side of the instrument panel.

 Do not attempt to service your vehicle if you do not have the required technical background. Failure to work in an informed, professional manner when servicing components and materials constitutes a safety hazard for vehicle occupants and other road users. If you are not familiar with the guidelines, please have the operations performed by your BMW center. ◀



To open

Pull the release handle and open the hood.

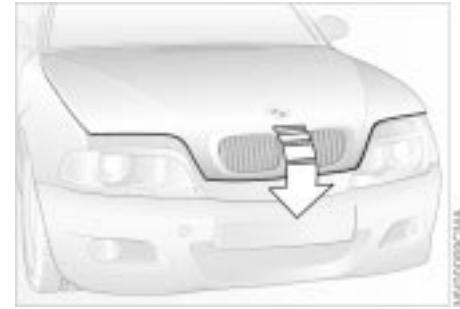

To close

Pull the hood downwards and allow the hood to fall from a minimum height of 12 in (30 cm) so that it audibly engages. Check for proper locking by pulling on the hood at the left and right above the headlamps.

 To avoid injuries, be sure that the travel path of the hood is clear when it is closed, as with all closing procedures. If it is determined that the hood is not completely closed while driving, stop immediately and close it securely. ◀

 It is not possible to accelerate from a standing stop using SMG II* when the hood is open. ◀

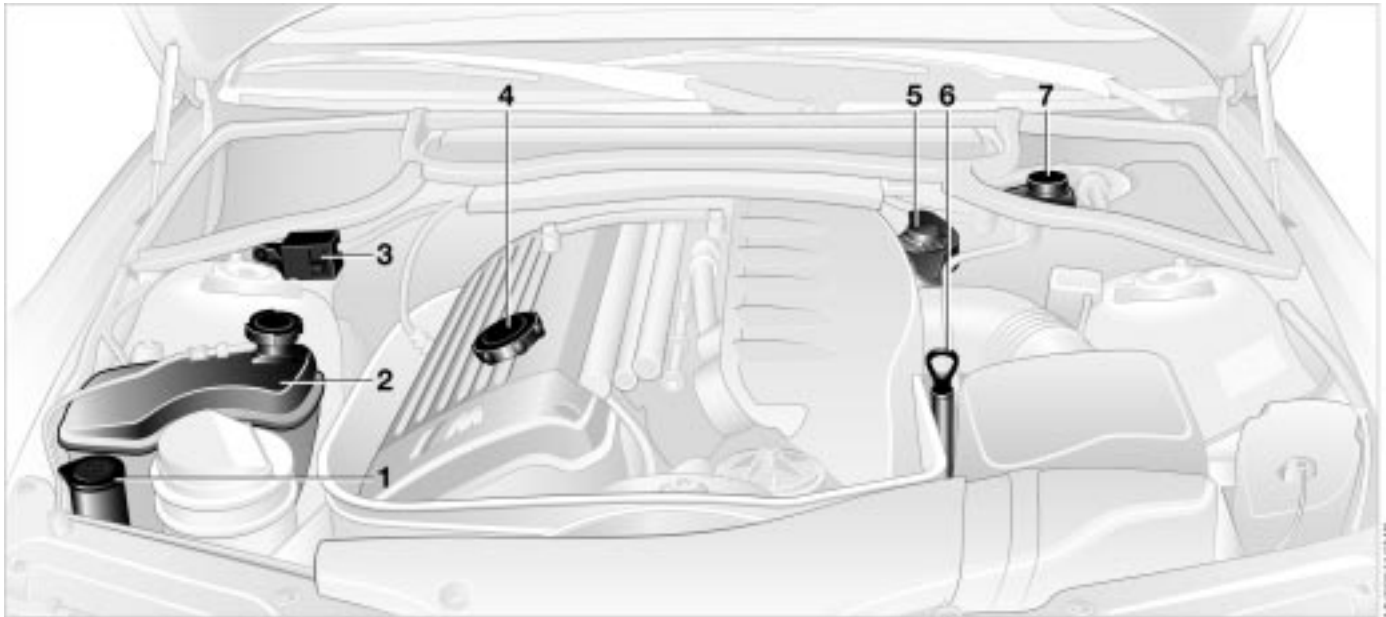

- 1 Filler neck for headlamp and windshield washer system [109](#)
- 2 Coolant expansion tank [112](#)
- 3 Positive terminal connection for jump-starting (positive terminal) [131](#)

- 4 Engine oil filler neck [110](#)
- 5 Expansion tank for SMG* hydraulic unit (checking and possible refilling by your BMW center) [59](#)

- 6 Engine oil dipstick [110](#)
- 7 Filler neck for brake fluid [113](#)

Washer fluids



Antifreeze agent for the washer systems is inflammable. For this reason, keep it away from sources of flame and store it only in its original containers. Store it inaccessible to children. Comply with the instructions on the containers. ◀

Headlamp and windshield washer system

Capacity: approx. 5.6 US quarts (5.3 liters).

Fill with water and – if required – with a washer antifreeze (according to manufacturer's recommendations).



We recommend that you mix the washer fluid before adding it to the reservoir. ◀



As with fuel economy, oil consumption is directly influenced by your driving style and vehicle operating conditions.

The oil volume between the two marks on the dipstick corresponds to approx. 1.4 US quarts (1.3 liter).



Checking engine oil level

1. Park the vehicle on a level surface
2. With the engine warmed to its normal operating temperature, allow it to idle for at least 15 seconds, then switch off
3. After approx. 1 minute, pull the dipstick out and wipe it off with a clean lint-free cloth, paper towel, or similar material
4. Carefully push the dipstick all the way into the guide tube and pull it out again
5. The oil level should be between the two marks on the dipstick.

Adding engine oil

While you should wait until the level has dropped to just above the lower mark before adding oil, you should never allow the oil level to fall below this mark.

Do not fill beyond the upper mark on the dipstick. Excess oil will damage the engine.

Before checking the engine oil level after topping up, restart the engine and allow it to run to obtain a correct display. Then proceed as described under "Checking engine oil level".

Engine oil

 BMW engines are designed to operate without oil additives; the use of additives could lead to damage in some cases. This is also true for the manual transmission, the differential, and the power steering system. ◀

Recommendation: have the oil changed by your BMW center only.

 Continuous exposure to used oil has caused cancer in laboratory testing. For this reason, thoroughly wash any areas of skin that come into contact with oil using soap and water. Always store oils, grease and similar materials so that they are inaccessible to children. Comply with warning labels and information on containers. ◀

 Comply with the applicable environmental laws regulating the disposal of used oil. ◀

Prescribed engine oil

The quality of the engine oil is extremely important for the function and life of an engine. Based on extensive testing, BMW has approved only certain types of engine oils.

Use only oils approved for your vehicle model.

 Ask your BMW center for details concerning oils that have been approved. You can also call BMW of North America at 1-800-831-1117 or visit this website: www.bmwusa.com to obtain this information. ◀

Alternative oil types

Should it not be possible to purchase an oil approved by BMW, you can also use other oils for adding smaller quantities between oil changes as an exception. The following information must be specified on the package:

1. Viscosity
preferred: SAE 10W-60
or as an alternative: SAE 5W-40 or SAE 10W-40
2. Specification
preferred: API SJ/CF
or as an alternative: API SJ
(also SK, SL, S etc.).

Low ambient temperatures

The oils used by BMW at the factory for your vehicle model can be used at virtually any ambient temperature.

However, if the vehicle is exposed to temperatures below -4°F (-20°C) for extended periods, please have your BMW center recommend a suitable oil.

 Do not add coolant to the cooling system when the engine is hot. If you attempt to do so, escaping coolant can cause burns.

To avoid the possibility of damage later on, never use anything other than factory-approved, nitrite and amino-free extended-duty antifreeze with corrosion inhibitor. Your BMW center is familiar with the official specifications. Antifreeze and anti-corrosion agents are hazardous to health. You should always store them in their original containers and in a location inaccessible to children. Extended-duty antifreeze with corrosion inhibitor contains ethylene glycol, a flammable substance. For this reason, do not spill extended-duty antifreeze with corrosion inhibitor on hot engine parts. It could catch fire and cause serious burns. ◀



Check the coolant level and add coolant

Check the coolant level when the engine is cold (approx. 68°F or +20°C).

1. Open the cap for the expansion tank by turning it slightly counterclockwise to allow accumulated pressure to escape, then open
2. The coolant level is correct when the upper end of the red float is at least even with the upper edge of the filler neck (refer to the arrow in the illustration), but no more than 0.8 in (2 cm) above it – that is, up to the second mark on the float (refer also to the schematic diagram next to the filler neck)

3. If necessary, add coolant. If the coolant is low, slowly add coolant until the correct level is reached – do not overfill.

 Comply with the applicable environmental laws regulating the disposal of extended-duty antifreeze with corrosion inhibitor. ◀

Brake fluid

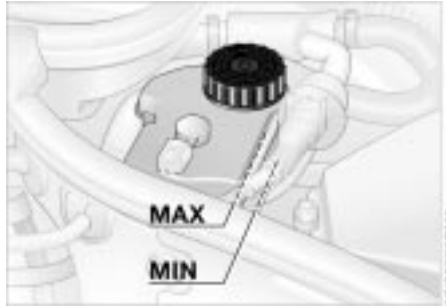

If the brake warning lamp comes on and the parking brake has been released: the brake fluid level is too low.



For adding brake fluid or for determining and correcting the cause of brake fluid loss, consult your BMW center. Your BMW center is familiar with the specifications for factory-approved brake fluids (DOT 4). Due to loss in brake fluid, pedal travel can lengthen and braking efficiency may be reduced. Comply with the information provided on page [102](#).



Brake fluid is hygroscopic, that is, it absorbs moisture from the air over time.

In order to ensure the safety and reliability of the brake system, have the brake fluid changed every two years by a BMW center. Refer also to the Service and Warranty Information Booklet (US models) or the Warranty and Service Guide Booklet (Canadian models). Brake fluid is toxic and damages the vehicle's paint. You should always store it in its original container and in a location inaccessible to children. Do not spill brake fluid and fill the brake fluid reservoir only as far as the "MAX" mark. The brake fluid could ignite upon contact with hot engine parts and cause serious burns. ◀



Comply with the applicable environmental laws regulating the disposal of brake fluid. ◀



The BMW Maintenance System has been designed as a reliable means of providing maximum driving and operating safety – and as cost-effectively as possible for you. Due to technical innovations, maintenance costs were again able to be markedly reduced with respect to the previous model.

Please keep in mind that regular maintenance is not only necessary for the safety of your vehicle, but also plays a significant role in maintaining the resale value of the vehicle.

Service Interval Display

While conventional systems rely on distance traveled alone to determine when service is due, the BMW Maintenance System has for years considered the actual conditions under which the vehicle operates, because miles can be traveled in many different ways:

For example, 62,000 miles (100,000 km) short-distance driving are not equal to the same 62,000 miles (100,000 km) of long-distance travel.

The BMW Maintenance System includes the Engine Oil Service and Inspections I and II.

Determining the maintenance intervals according to the actual loads on the vehicle covers every kind of operating situation. Those who are outright "Sunday drivers," driving fewer than 6,000 miles (10,000 km) per year – should, nevertheless have their oil changed every 2 years at the most, no matter what the Service Interval Display indicates, since engine oil breaks down over time, regardless of use.

Service and Warranty Information Booklet (US models)/Warranty and Service Guide Booklet (Canadian models)

For additional information on required maintenance intervals and procedures, please refer to the Service and Warranty Information Booklet (US models), or the Warranty and Service Guide Booklet (Canadian models).

As a precaution against corrosion, if your vehicle is exposed to potential damage from unimproved road surfaces we suggest that you have the body checked for damage from stone chips and gravel at the same time.

 Have your BMW center do the maintenance and repair.

Be sure that all maintenance work is confirmed in the Service and Warranty Information Booklet (US models), or in the Warranty and Service Guide Booklet (Canadian models). These entries are your proof that the vehicle has received regular maintenance. They are also a requirement for warranty claims. ◀

Light-Emitting Diodes (LEDs)

Light-emitting diodes installed behind translucent lenses serve as the light source for many of the controls and displays in your vehicle. The concept behind their operation is related to that employed for lasers, and they are officially designated as Class 1 light-emitting diodes.

 Do not remove the protective lens and avoid staring directly at the unfiltered beam for extended periods (several hours), as inflammation of the iris could result. ◀

California laws require us to state the following warning:

 Engine exhaust, some of its constituents, and certain vehicle components contain or emit chemicals known to the State of California to cause cancer and birth defects or other reproductive harm. ◀



The Onboard Diagnostic (OBD) interface socket is located on the left of the driver's side at the bottom of the instrument panel and under a cover. The cover has the letters "OBD" on it.

The purpose of the OBD system is to assure proper emission-control system operation for the vehicle's lifetime by monitoring emission-related components and systems for deterioration and malfunction.



An illuminated lamp informs you of the need for service, not of the need to stop the vehicle.

However, the systems should be checked by your BMW center at the earliest possible opportunity

If the indicator blinks or flashes, this indicates a high level of engine misfire.

Reduce speed and contact your nearest BMW center immediately. Severe engine misfiring over even a short period of time can seriously damage emission-control system components, especially the catalytic converter.



Service Engine Soon warning lamp for Canadian models



If the fuel filler cap is not on tight enough, the OBD system can detect leaking vapor and the indicator will light up. If the fuel filler cap is then tightened, the indicator will usually go out after a short period of time. ◀





Overview

Controls and features

Operation, maintenance

Owner service procedures

Technical data

Index

Overview

Controls

Maintenance

Repairs

Data

Index

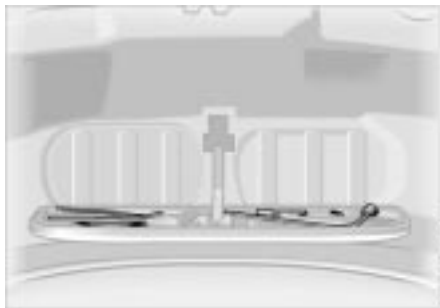

The onboard tool kit is located in the luggage compartment lid.

Loosen the wingnut to open.

Windshield wiper blades



1. Rotate the wiper arm completely out from the windshield
2. Position the wiper blade at an angle and pull the release spring (arrow)
3. Fold the wiper blade down and unhook it toward the windshield
4. Pull the wiper blade past the wiper arm toward the top
5. Insert a new wiper blade and apply pressure until you hear it engage.

 Use only wiper blades approved by BMW. ◀

Lamps and bulbs

The lamps and bulbs make essential contributions to the safety of your vehicle. Therefore, comply fully with the following instructions during bulb replacement. If you are not familiar with any of the procedures, consult your BMW center.

 Do not touch the glass portion of a new bulb with your bare hands since even small amounts of impurities burn into the surface and reduce the service life of the bulb. Use a clean cloth, paper napkin, or a similar material, or hold the bulb by its metallic base. ◀

A replacement bulb set is available from your BMW center.

 Whenever working on the electrical system, switch off the electrical accessory you are working on or disconnect the cable from the negative terminal of the battery. Failure to do this could result in short circuits.

To prevent injuries and damage when changing a bulb, be sure to comply with any instructions provided by the bulb manufacturer. ◀

Lamps and bulbs

Low and high beams

- ▷ Low beams: H7 bulb, 55 watts
- ▷ High beams: H7 bulb, 55 watts



The H7 bulb is pressurized. Therefore, wear safety glasses and protective gloves. Failure to comply with this precaution could lead to injury if the bulb is damaged during replacement. ◀

Please contact a BMW center in case of malfunction.

Standing lamps

5 watt bulb

Please contact a BMW center in case of malfunction.

When caring for your headlamps please observe the notes and instructions contained in the "Caring for your vehicle" manual.

Xenon lamps*

The service life of these bulbs is very long and the probability of a failure is very low, provided that they are not switched on and off an unusual number of times. If one of these bulbs should nevertheless fail, it is possible to continue driving with great caution using the fog lamps, provided traffic laws in your area do not prohibit this.



Because of the extremely high voltages involved, any work on the xenon lamps should be carried out by technically qualified personnel only. Otherwise, there is a risk of fatal injury. ◀

122 Lamps and bulbs



Turn signal indicator, front

21 watt bulb

1. Using a screwdriver, release the inner hook through the upper opening
2. Remove lamp by pulling it out toward the front
3. Applying light pressure, turn the bulb to the left. Remove and replace the bulb

4. Insert the 2 pins on the lamp into the guides on the vehicle
5. Push the lamp in. Carefully apply pressure until you hear it snap into place.

Side turn signals

5 watt bulb

1. Use finger pressure against the rear end of the lens (arrow) to press it forward for removal
2. Apply gentle pressure to the bulb while turning it to the left to remove.



Front fog lamps

HB4 bulb, 55 watts

 The bulb is pressurized. Therefore, wear safety glasses and protective gloves. Failure to comply with this precaution could lead to injury if the bulb is damaged during replacement. ◀

Please contact a BMW center in case of malfunction.



Tail lamps

Tail lamps (4): bulbs 21/4 watts

Remaining bulbs: 21 watts

- 1 Turn signal indicator
- 2 Backup lamps
- 3 Tail lamp
- 4 Tail lamp/brake lamp

yellow
white
red
red

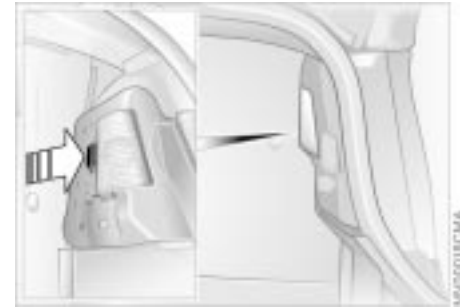

The illustration shows the right-hand luggage compartment opening.

Bulbs in the fender

All of the bulbs are integrated in a central bulb holder.

1. Release the bulb holder (arrow)

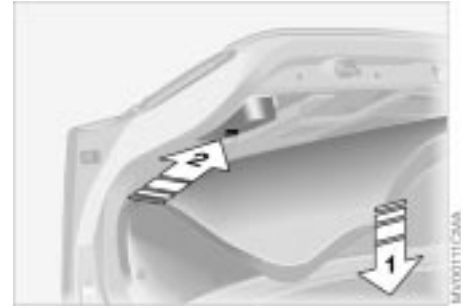
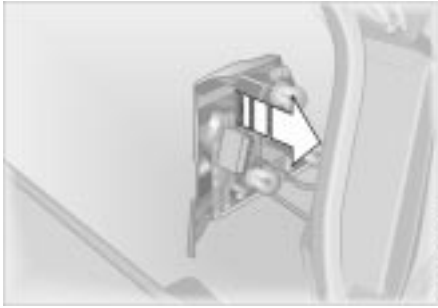

2. Take out the bulb holder
3. Unplug the power supply receptacle. Set the bulb holder aside (on the luggage compartment floor, for example)
4. Applying light pressure, turn the bulb to the left. Remove and replace the bulb
5. Plug in the power supply receptacle
6. Reattach the bulb holder until you hear it snap into place (Illustration).

Bulbs in the luggage compartment lid

1. Using a screwdriver, loosen the clip

2. Fold the trim panel down (arrow 1). Disengage the bulb holder (arrow 2) and remove it
3. Applying light pressure, turn the bulb to the left. Remove and replace the bulb
4. Press the bulb holder into position until you hear it engage
5. Reinstall the trim with the clip.



Center (high-mount) brake lamp

LED light bar on the rear window.

Please contact a BMW center in case of malfunction.



License plate lamps

5 watt bulb

1. Place a screwdriver in the slot and press toward the left (arrow) to release the lens
2. Replace the bulb.



Precautions in case of a flat tire: Stop the vehicle as far as possible from passing traffic; switch on the hazard warning flashers.

Turn the steering wheel to the straight-ahead position and engage the steering lock. Shift into 1st or reverse and engage the parking brake.

All passengers should be outside the vehicle and well away from your immediate working area (behind a guardrail, for instance).

If a warning triangle or portable hazard warning lamp is available, set it up on the roadside at an appropriate distance from the rear of the vehicle.

Comply with all safety guidelines and regulations. ◀

M Mobility system

With the BMW M3, you will find an M Mobility system for fixing flat tires. With the aid of this system, you can apply a liquid sealant to the inside of the tire, thereby sealing off the damaged area, and then continue driving.

The M Mobility system makes transporting a spare wheel superfluous, thereby reducing the amount of weight you have to carry around.

Using the M Mobility system

To repair a flat tire using the M Mobility system, proceed as follows:

- ▷ Prepare the M Mobility system for use, refer to the next column
- ▷ This is part of the M Mobility system, refer to page [127](#)
- ▷ Filling with sealant, refer to page [127](#)
- ▷ Distributing sealant, refer to page [128](#)
- ▷ Inflating tire to correct pressure, refer to page [129](#).



Preparing the M Mobility system for use

The M Mobility System is located in the luggage compartment under the floor panel:

1. Lift up the floor panel
2. Loosen the M Mobility system from its storage location.



Before you use the M Mobility system, read the warnings and danger notices on the device carefully. ◀

If possible, leave the foreign object in the tire.

Pull off the sticker 5 (refer to the second column on the right) for the speed limit and apply it to the steering wheel.

Repairing a flat tire

 Please keep in mind that the fluids bottle in the system's sealant container has to be changed every 3 years by your BMW center, if the unit has not been used. ◀



This is part of the M Mobility system

- 1 On/Off switch
- 2 Connection hose with manometer for connecting the compressor with the sealant container or to connect the compressor to the wheel
- 3 Manometer for indicating the tire pressure
- 4 Connector hose from the sealant container to the wheel
- 5 Sticker for maximum speed
- 6 Plug and cable for the cigarette lighter socket
- 7 Protective gloves (not shown).

Filling with sealant

1. Take the round cover off and hose 4 out. Unscrew the valve stem dust cap from the defective wheel and screw the hose to the valve. Keep the dust cap in a safe place.



Distributing the sealant

Right afterward, drive at least 1.2 miles (2 km), so that the liquid sealant distributes evenly throughout the inside of the tire.

 Do not exceed a maximum speed of 40 mph (60 km/h). If possible, keep the vehicle speed above 10 mph (20 km/h). Stop in a suitable spot. ◀

2. Flip open the cover and pull on the enclosed protective gloves. Take out hose 2 with the manometer and screw it to the terminal for the sealant container as shown in the illustration
3. Make sure that the system has been switched off (Position 0). Take out plug 6 and insert it into the cigarette lighter socket in the passenger compartment (refer to page 93)
4. Make sure that the screw on the rear of manometer 3 is tightened down. Turn on the M Mobility system (Position I, refer to illustration) and allow minutes to elapse, to let the sealant flow in. It does not matter afterward, what the tire's inflation pressure is
5. Turn the sealant off. Disconnect the connector hose from the sealant container and the wheel valve. Stow the M Mobility system in the luggage compartment



Inflating tire to correct pressure

1. Take the hose with the manometer out and screw it onto the valve. Take the plug out and plug it into the cigarette lighter socket in the passenger compartment
2. Reset the air pressure to 29 psi (200 kilopascal), and:
 - ▷ Increase tire pressure: turn on the M Mobility system (Position I). Turn the unit off while you check the current setting for the tire pressure
 - ▷ Decrease tire pressure: turn the screw on the back of the manometer, a valve located there will open

▶ Even if the tire fails to hold the pressure, you should still carry out Step 3 before proceeding to drive the vehicle again, refer to "Distributing sealant" for more information. Then repeat Steps 1 through 3. The use of the M Mobility system may be ineffective if the damaged area in the tire is larger than approx. 0.16 in (4 mm). Please consult the nearest BMW center if the tire cannot be temporarily repaired with the M Mobility system. ◀

3. Unscrew the hose from the valve and stow the M Mobility system in the luggage compartment. Screw the dust cap onto the valve again.

⚠ Do not exceed the maximum speed limit described below, otherwise it could lead to accidents. ◀

After the flat tire has been fixed and you start driving again, do not exceed a maximum speed of 45 mph (80 km/h).

▶ You will find corresponding instructions for using the M Mobility system on the device. Replace the defective tire as soon as possible and have the new wheel balanced. Reinitialize the Flat Tire Monitor, and refer to page 78 for further information. Have the M Mobility system refilled. Contact your BMW center for this. ◀

Protect valve stems against dirt using screw-on dust caps. Dirty valve stems frequently lead to slow pressure loss.

 Battery posts, terminals, and related accessories contain lead and lead compounds. Wash hands after handling. ◀

Battery care

The battery is completely maintenance-free. That means that the original battery acid will normally last for the service life of the battery under moderate climate conditions.

 Please consult your BMW center whenever you have any questions concerning the battery. Since the battery is absolutely maintenance-free, the following statements are for your information only. ◀

 Never disconnect the battery when the engine is running; the ensuing voltage surge would seriously damage the vehicle's onboard electronic systems. ◀

Charging the battery

Charge the battery in the vehicle only when the engine is not running. Use the connections provided in the engine compartment (for correct connections, refer to "Jump-starting" on page 131).



Return used batteries to a recycling point or your BMW center. Maintain the battery in an upright position for transport and storage. Secure the battery against tilting in transit. ◀

Fuses

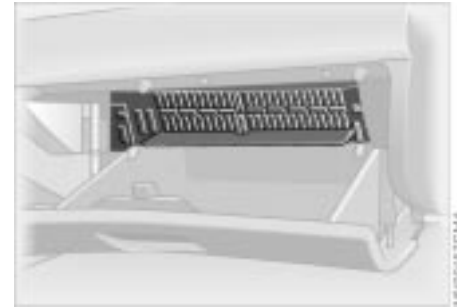

Open the glove compartment and turn the two white quick-release fasteners outward.

 Do not attempt to repair a burned fuse or replace it with a fuse having a different color or ampere rating. To do this could cause a fire in the vehicle resulting from a circuit overload. ◀

Jump-starting

Do not use spray starter fluids to start the engine.

When your battery is discharged you can use two jumper cables to start your vehicle with power from the battery in a second vehicle. You can also use the same method to help start another vehicle. Use only jumper cables with fully insulated handles on the terminal clamps.

⚠ Do not touch the parts conducting current while the engine is running. Failure to comply with this creates a risk of fatal injury. Carefully observe the following instructions to avoid personal injury and/or damage to one or both vehicles. ◀

1. Ensure that the battery in the support vehicle is also rated at 12 volts. This information is provided on the top of the battery casing
2. Do not disconnect your battery from your vehicle's electrical system. Switch off all electrical accessories in both vehicles
3. Make absolutely certain that there is no contact between the bodywork of the two vehicles – short circuit hazard
4. Start the engine on the support vehicle and allow it to run

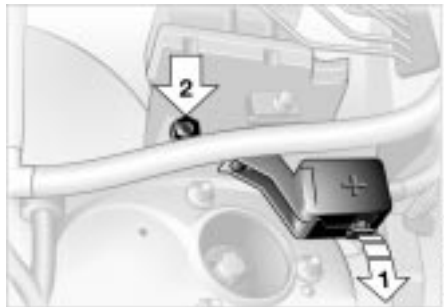

5. Use one jumper cable (+) to connect the positive terminal of the battery in the support vehicle with the auxiliary positive terminal provided in the engine compartment of your BMW specifically for jump-starting. The cover of the positive terminal connector is marked with a "+" sign. Refer to the illustration. Remove by pulling the tab (arrow 1)
6. Next, connect one end of the other jumper cable (-) to either the support vehicle's negative battery terminal or a suitable ground on its engine or bodywork. Connect the other end to the negative battery terminal or a suitable ground on the vehicle being started. There is a special nut provided for this on the BMW (arrow 2)

⚠ Always adhere to this sequence when connecting jumper cables; failure to observe this procedure can lead to sparks at the battery terminals and pose an injury hazard. ◀

7. Allow the engine of the support vehicle to run at a fast idle for several minutes, then start the engine on the vehicle with the discharged battery in the usual manner. If the first start attempt is not successful, wait a few minutes before another attempt in order to allow the discharged battery to recharge
 8. Allow the engines to run for several minutes before disconnecting the jumper cables
 9. Then disconnect the jumper cables in the opposite order.
- Have the battery recharged at your BMW center as required.

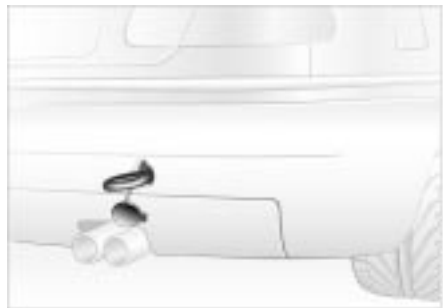

Tow fitting

The tow fitting, which can be unscrewed, is in the luggage compartment under the floor panel and must remain in the vehicle. This fitting is designed for installation in the tow sockets located at the front and rear of the vehicle. It is intended for towing on paved road surfaces only.

It should not be used to pull a vehicle out of deep snow, mud, sand, etc. Comply with all applicable towing laws and regulations at all times.

Access to tow sockets

Front:

Press out the cover panel with a screwdriver above on the recess.

Rear:

Press out the cover panel with a screwdriver above on the recess.

 Screw the tow fittings in until they are tight. If you do not, the threads could be damaged.

Do not tow the vehicle by any components of the running gear, or lash them down in any way. If you do, the components could be damaged, leading to possible accidents. ◀

 Keep the vehicles in line and avoid towing at an offset angle. Ensure that the tow rope connecting the two vehicles is tight, with no slack, before starting off. ◀

Use only a nylon towing strap to tow the vehicle, since the inherent resilience of this material helps protect both vehicles from sudden jerking movements.

 The towed vehicle should always be the lighter of the two vehicles. If this is not the case, it will not be possible to control vehicle handling. ◀

Tow-starting

For instructions on jump-starting, refer to page 131.

Never attempt to use your vehicle to push another vehicle, since damage to the energy-absorbing bumpers could result.

Towing the vehicle

Towing a vehicle

1. Shift lever in Neutral
2. Towing speed:
Max. 45 mph (70 km/h)
3. Towing distance:
Max. 95 miles (150 km)
4. Leave the ignition key at position 1 to ensure that the brake lamps, turn signal indicators, horn and windshield wipers remain operative, and to prevent the steering lock detent from engaging
5. Switch on the hazard-warning system (observe applicable legal regulations).

Find some means of identifying the vehicle in tow, for instance, place a sign or warning triangle in the rear window.

 Make sure that the ignition key remains in position 1 even when the electrical system has failed to prevent the steering lock from engaging.

The steering and brakes are without power assist when the engine is off. This means that increased effort is required for steering and braking. ◀

Vehicles with sequential M gearbox* SMG II:

To push or tow, engage selector lever in position 0.



Never work on the vehicle with a driving position engaged. ◀

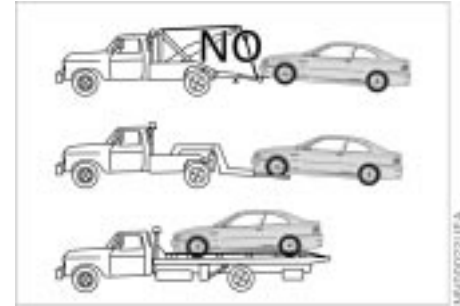

Towing with a commercial tow truck

- ▷ Do not tow with sling-type equipment
- ▷ Use wheel lift or flatbed equipment
- ▷ Please comply with applicable state towing laws.

 Never allow passengers to ride in a towed vehicle for any reason. Never attach tie-down hooks, chains, straps, or tow hooks to tie rods, control arms, or any other part of the vehicle suspension, as severe damage to these components will occur, leading to possible accidents. ◀

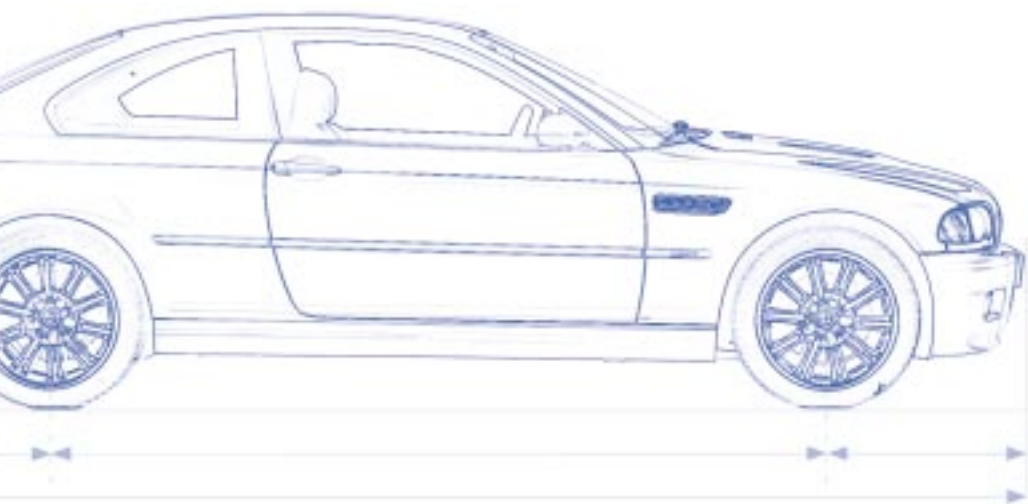

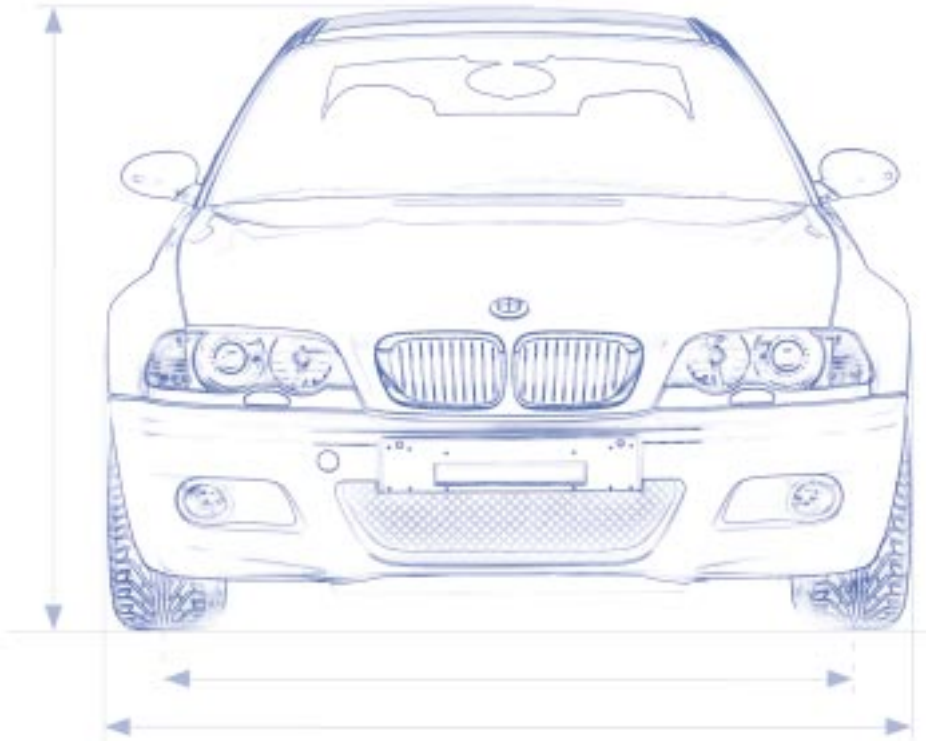
[Overview](#)[Controls and features](#)[Operation, maintenance](#)[Owner service procedures](#)[Technical data](#)[Index](#)

Overview

Controls

Maintenance

Repairs

Data

Index

136 **Engine data**

Displacement	cu in (cm ³)	198.1 (3,246)
Number of cylinders		6
Max. output at engine speed	hp rpm	333 7,900
Max. torque at engine speed	lb-ft (Nm) rpm	262 (355) 4,900
Compression ratio	ϵ	11.5
Stroke	in (mm)	3.58 (91)
Bore	in (mm)	3.43 (87)
Fuel-injection system		Digital electronic engine-management system

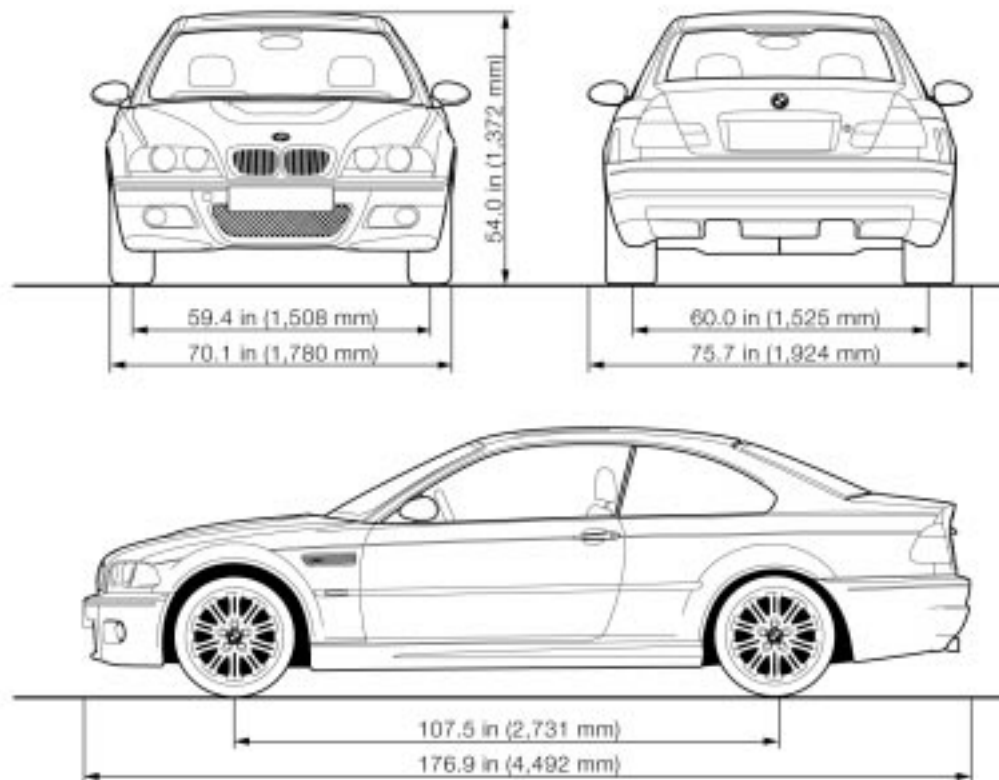

Smallest turning radius dia.: 36.1 ft (11.0 m).

138 Weights

Curb weight (with one person, ready for operation,
full tank of fuel, options not included)

	lbs (kg)	3,415 (1,549)
Approved gross vehicle weight	lbs (kg)	4,453 (2,020)
Approved front axle weight	lbs (kg)	2,138 (970)
Approved rear axle weight	lbs (kg)	2,535 (1,150)
Approved roof load capacity	lbs (kg)	165 (75)
Luggage compartment capacity	cu ft (l)	14.5 (410)

Approved axle loads and approved gross vehicle weight may not be exceeded.

			Notes
Fuel tank	gal. (liters)	approx. 16.6 (approx. 63)	Fuel specification: page 24
Reserve	gal. (liters)	approx. 2.1 (approx. 8)	
Windshield and headlamp washer reservoir	quarts (liters)	approx. 5.6 (approx. 5.3)	Specifications: page 109
Cooling system including heater circuit	quarts (liters)	approx. 9.9 (approx. 9.3)	Specifications: page 112
Engine oil and filter change	quarts (liters)	approx. 5.3 (approx. 5.0)	Specifications: page 111
Manual transmission	quarts (liters)	approx. 1.9 (approx. 1.8)	Oil change during break-in inspection and during each inspection II
Differential	quarts (liters)	approx. 1.2 (approx. 1.1)	Oil change during break-in inspection and during each inspection II

A B C

P Q R



Overview

Controls and features

Operation, maintenance

Owner service procedures

Technical data

Index

Overview

Controls

Maintenance





Repairs

Data

Index

Everything from A to Z



A

ABS (Antilock Brake System) 19, 101
Accessories 10
Activated charcoal filter 89
Adding
 brake fluid 113 
 engine coolant 112 
 engine oil 110 
 washer fluid 109 
Adjusting 44
 backrests 44
 head restraints 44
 interior
 temperature 84, 87
 lumbar support 43
 seats 43
 steering wheel 47
 thigh support 43
Air conditioner 83, 88
Air distribution 84
Air distribution,
 automatic 87
Air nozzles 83, 86
Air outlets 83, 86
 ventilation 83, 86
Air pressure, tires 24, 103
Air supply 84, 87

Air supply vents
 recirculated-air mode 88
Airbags 49
 warning lamp 18
Alarm system 37
Antifreeze 112
Antilock Brake System
 (ABS) 19, 101
Anti-theft alarm system 37
Anti-theft system 28
Aquaplaning 101, 103
Armrest 91
Ashtray
 front 92
 rear 93
Attaching power
 supplies 93
AUC (Automatic
 recirculated-air
 control) 88
Automatic climate
 control 86
Automatic cruise control 68
Automatic headlamp
 control 80
Automatic recirculated-air
 control (AUC) 88
Auxiliary terminal for jump-
 starting 108 

Average consumption 74
Average speed 74
Avoiding unintentional
 alarms 38
Axle loads 138

B









Backrests
 adjusting 44
 unlocking 45
Backup lamps 59
 bulb replacement 123 
Battery 130
 care 130
 charging 130
 current warning lamp 17
Battery charge current 17
Belts 45
Beverage holder 91
Blower 84, 87
Bore 136
Bottle holder, refer to
 beverage holder 91
Brake lamps
 bulb replacement 123 

Brake system
 brake fluid level 102
 brake pads 102
 brake pads, indicator
 lamp 19
 disc brakes 102
 malfunction 102
 warning lamps 17
Break-in procedure 100
Bulb replacement 120 
Bulbs 120

C

California Proposition
 65 Warning 115
Can holder, refer to
 beverage holder 91
Capacities 139
Car care, refer to the "Caring
 for your vehicle" manual
Car radio, refer to the
 separate Owner's Manual
Car telephone 92
Car wash systems, refer to
 the "Caring for your
 vehicle" manual
Cargo loading 96, 97

Everything from A to Z



- Caring for headlamp covers, refer to the "Caring for your vehicle" manual
- Caring for your vehicle's paintwork, refer to the "Caring for your vehicle" manual
- CBC (Cornering Brake Control) 101
 - warning lamp 18
- Cellular phone 92
 - refer also to the separate Owner's Manual
- Center (high-mount) brake lamp 125
- Center armrest 91
- Central locking system 28
 - key 33
- Check Control 72
- Checking
 - engine coolant 112 
 - engine oil level 110 
 - tire inflation pressures 24 
- Child seat security 54
- Child-restraint systems 52
- Cigarette lighter 93
- Clean the headlamps 67
- Clean the windshield 67
- Clock 72
 - also refer to the "Radio Owner's Manual"
- Clothes hooks 93
- Cockpit 14
- Coin box 91
- Combination switch 65
- Compression 136
- Computer 72
 - refer also to the "Onboard Computer Owner's Manual"
- Configuring individual settings with Vehicle and Key Memory 55
- Connecting car vacuum cleaner 93
- Consumption 74
- Consumption display 71
- Control elements 14
- Coolant 112
- Coolant system, capacity 139
- Coolant temperature gauge 71
- Copyright 4
- Cornering Brake Control (CBC) 101
 - warning lamp 18
- Cover, sun blinds 89
- Cruise control 68
- Cruising range 74
- Curb weight 138
- D**
- Data
 - dimensions 137
 - engine 136
 - technical 136
 - weights 138
- Daytime driving lamps 80
- DBC (Dynamic Brake Control) 77
- Deep water 101
- Defrostable rear window 88
- Defroster, rear window 84
- Defrosting windows 87
- Dimensions 137
- Dipstick, engine oil 110
- Disc brakes 102
- Displacement 136
- Display lighting 81
- Distance warning 75
- Divided rear backrest 94
- Door key 28
- Doors
 - electrical malfunction 29 
 - manual operation 29 
 - operating manually 29
 - remote control 30
 - unlocking and locking 29, 30
- Draft-free ventilation 85, 88
- Driving notes
 - aquaplaning 101
 - brakes 101
- DSC (Dynamic Stability Control) 76
 - indicator lamp 19
- Dynamic Brake Control (DBC) 77
- Dynamic Stability Control (DSC) 76
 - indicator lamp 19
- E**
- Electric power windows 39
- Electrical malfunction
 - doors 29 
 - fuel filler door 22 
 - luggage compartment lid 34
 - sliding/tilt sunroof 41 

Everything from A to Z

Emergency release of
luggage compartment lid
from luggage
compartment's interior 36



Engine
displacement 136
starting 56 
torque 136

Engine compartment
essentials 108

Engine coolant 112
add 112 
checking 112 



Engine cooling system,
capacity 139



Engine data 136

Engine oil
adding 110 
capacity 139
consumption 110
for low ambient
temperatures 111
level, checking 110 
level, indicator lamp 17
pressure 17
pressure, indicator
lamp 17
quality 111

specifications 111
thermometer 70
viscosity 111
Engine speed 136
Entry to the rear 45
Exterior mirrors 48

F

Failure messages 72
Filling capacities 139
Filling the washer
reservoir 109 
First-aid kit 22
Flat tire 103
repairing 126
Flat Tire Monitor 77
indicator lamp 17, 19
Fog lamps 82
bulb replacement 123 
Folding rear backrest 94
Follow me home lamps 80
Footbrake 102
Footwell lamps 82
Front seat adjusting 42
Frost protection,
radiator 112
Fuel 24
Fuel consumption 74

Fuel consumption
display 71
Fuel filler door 22
electrical
malfunction 22 
manual operation 22 
Fuel gauge 71
Fuel quality 24
Fuel reserve indicator
lamp 71
Fuel tank capacity 139
Fuel tank gauge 71

G

Gasoline 24
Gasoline gauge 71
Gearshift lever 58
Glove compartment 90
Gross vehicle weight 138

H

Handbrake 58
Hands-free system 92
Hazard warning triangle 22
Head restraints 44
adjusting 44

Headlamp cleaning
system 108
Headlamp control 80
Headlamp flasher 81
Headlamp washer
system 139
Heated seats 47
Heavy loads 96
Height 137
HiFi system 90
High beams 65, 81
indicator lamps 20
Holder for beverages 91
Hood release 107 
Horn 14

I

Ice warning 73
Identification, tires 105
Ignition key 28
Ignition key positions 56
Ignition lock 56
Imprint 4
Indicator lamps 17
Individual settings with
Vehicle and Key
Memory 55
Inflation pressure,
tires 24, 103

Everything from A to Z

INSPECTION 71

- Instrument cluster 15
- Instrument lighting 81
- Instrument panel 15
- Interface socket
 - for Onboard Diagnostics 116
- Interior lamps 31, 82
 - remote control 31
- Interior motion sensor 37, 38
 - avoiding unintentional alarms 38
 - deactivate 31
 - operating via remote control 31
- Interior rearview mirror with automatic dimming feature 49



J

- Jump-starting 131





K

- Key 28
 - with remote control 28
- Key Memory 55

L

- Lamps 80, 120
- LAMPS ON warning 80
- Lashing eyes 97
- LATCH child-restraint system installation 53
- Leather care, refer to the "Caring for your vehicle" manual
- Length 137
- License plate lamp
 - bulb replacement 125 
- Lighting, refer to lamps
- Load-securing devices 97
- Locking luggage compartment lid separately 34
- Louvers 83, 86
- Low ambient temperatures 111
- Low beams 80
 - bulb replacement 121 
- Luggage compartment
 - capacity 138
 - floor mat 36
 - floor panel 36
 - lighting 34
 - operating via remote control 31
- Luggage compartment lid 34
 - electrical malfunction 34
 - emergency release from luggage compartment's interior 36
 - locking it separately 34
 - manual operation 34 
- Luggage rack 97
- Lumbar support, adjusting 43

M

- M Engine dynamics control 79
- M+S-tires 106
- Maintenance 71, 114
- Malfunction displays 72
- Manual operation
 - doors 29 
 - fuel filler door 22 
 - luggage compartment lid 34 
 - sliding/tilt sunroof 41 
- Manual transmission 58
- Master key 28

- MFL (Multifunction steering wheel) 21
- Microfilter 85, 89
- Mirror memory 46
- Mirrors 48
 - automatic curb monitor 48
- Modifications, technical 10, 115
- Multifunction steering wheel (MFL) 21

N

- Navigation system, refer to the "Onboard Computer Owner's Manual"
- Neckrest 44

O

- OBd interface socket 116
- Obstruction protection 39
- Odometer 70
- Oil
 - additives 111
 - capacity 139
 - quality 111
 - specifications 111
 - viscosity 111

Everything from A to Z

Oil change intervals, see the Service and Warranty Information Booklet (US models) or the Warranty and Service Guide Booklet (Canadian models).

Oil consumption [110](#)

Oil filter change [139](#)

Oil level, indicator lamp [19](#)

OILSERVICE [71](#)

Onboard computer [72](#)
refer to the "Onboard Computer Owner's Manual"

Onboard tool kit [120](#)

Opening and closing
from inside [33](#)

via remote control [30](#)

via the door lock [29](#)

Operating vehicle at low ambient

temperatures [111](#)

Outside temperature display [73](#)

P

Park Distance Control (PDC) [75](#)

Parking brake [58](#)

Parking help [75](#)

Parking lamps [80](#)

PDC (Park Distance Control) [75](#)

Performance [136](#)

Pollen filter [85](#), [89](#)

Power windows [39](#)

R

Radiator [139](#)

Radio navigation system,
refer to the "Radio Owner's Manual"

Radio, refer to the separate Owner's Manual

Rain sensor [66](#)

Reading lamps [82](#)

Rear backrest, folding [94](#)

Rear lamps, refer to tail lamps [123](#)

Rear view mirror [48](#)

Rear window

defroster [84](#), [88](#)

Rear-entry assist [45](#)

Recirculated-air mode [84](#), [88](#)

Reclining seat [42](#)

Refueling [22](#)

Releasing

fuel filler door following an electrical

malfunction [22](#)

Remote control [30](#)

Removing condensation from the windows [87](#)

Repairing a flat tire [126](#)

Replace windshield wiper blades [120](#)

Replacement key [28](#)

Replacing bulbs [120](#)

Reporting safety defects [11](#)

Roller sun blind [89](#)

Roof load capacity [138](#)

Roof-mounted luggage rack [97](#)

S

Safety belts [45](#)

height adjustment [45](#)

three-point safety belt [94](#)

Safety buttons [33](#)

Safety feature [39](#)

Seat heating [47](#)

Seat memory [46](#)

Seats, adjusting [42](#)

Securing cargo [96](#)

Securing loads [96](#)

Self-defrosting mirrors [48](#)

Sequential M gearbox SMG II [59](#)

Service and Warranty Information Booklet [114](#)

Service Interval

Display [71](#), [114](#)















Side airbags [49](#)

Side impact Head Protection System [49](#)

Side turn signals

bulb replacement [122](#)

Ski bag [95](#)

- Sliding/tilt sunroof [40](#)
 - closing after electrical fault [41](#) 
 - convenience operation mode [29](#)
 - electrical malfunction [41](#) 
 - manual operation [41](#) 
 - remote control [30](#)
- Snow chains [106](#)
- Sockets for towing [132](#) 
- Sound system [90](#)
- Spare key [28](#) 
- Speaker [92](#)
- Speedometer [15](#)
- Sport-mode identification [79](#)
- Standing lamps [81](#)
 - bulb replacement [121](#) 
- Starting problems [57](#) 
- Starting the engine [57](#)
- Steering lock [56](#)
- Steering wheel, adjusting [47](#)
- Stopping the vehicle [57](#)
- Storage areas [91](#)
- Stroke [136](#)
- Summer tires [105](#)
- Sun blind cover [89](#)
- Surface ice warning [73](#)
- Switching off the engine [57](#)
- Switching off the interior motion sensor [38](#)
- Switching off the tilt alarm sensor [38](#)
- Symbols, used [8](#)
- T**
- Tail lamp assembly
 - bulb replacement [123](#) 
- Tail lamps [123](#)
 - bulb replacement [123](#) 
- Tank capacity [139](#)
- Technical data [136](#)
- Technical
 - modifications [10](#), [115](#)
- Telephone hookup [92](#)
- Temperature display
 - outside temperature [73](#)
- Temperature gauge
 - engine coolant [71](#)
- Temperature layering [85](#), [88](#)
- Temperature, adjusting [84](#), [87](#)
- Thigh support, adjusting [43](#)
- Third brake lamp [125](#)
- Through-loading system [94](#)
- Tilt alarm sensor [38](#)
 - avoiding unintentional alarms [38](#)
 - deactivate [31](#)
 - operating via remote control [31](#)
- Tire codes [105](#)
- Tire damage [103](#) 
- Tire inflation pressures [24](#), [25](#), [103](#)
- Tire Quality Grading [104](#)
- Tire replacement [104](#)
- Tire tread [103](#)
- Tool kit [120](#)
- Torque [136](#)
- Tow sockets [132](#) 
- Towing the vehicle [132](#) 
- Track [137](#)
- Transmission [58](#)
- Transporting children safely [52](#)
- Tread depth, tires [103](#)
- Tread wear indicator [103](#)
- Trip odometer [70](#)
- Trunk lid, refer to luggage compartment lid [34](#)
- Turn signal indicator [65](#)
 - bulb replacement [122](#) 
 - indicator lamps [20](#)
- Turning radius [137](#)
- U**
- Uniform Tire Quality Grading [104](#)
- Upholstery material, refer to the "Caring for your vehicle" manual
- Used batteries [130](#) 
- V**
- Vehicle battery [130](#)
- Vehicle Memory [55](#)
- Vehicle weight [138](#)
- Ventilation [83](#), [86](#)
 - draft-free [85](#), [88](#)
- Viscosity rate, oil [111](#)

Everything from A to Z

W

- Warning lamps [17](#)
- Warning messages [72](#)
- Warning triangle [22](#)
- Warranty and Service Guide
Booklet [114](#)
- Washer fluid reservoir,
capacity [139](#)
- Washing your vehicle, refer
to the "Caring for your
vehicle" manual
- Water on roadways [101](#)
- Wear indicator in the
tires [103](#)
- Weights [138](#)
- Wheel rims [105](#)
- Wheelbase [137](#)
- Wheels and tires [105](#)
- Width [137](#)
- Windows
 - convenience
 - operation [29, 30](#)
 - remote control [30](#)
- Windshield washer reservoir,
capacity [139](#)
- Windshield wiper [66](#)
- Winter tires [106](#)
- Wiper system [66](#)
- Work in the engine
compartment [107](#) 

X

- Xenon lamps [121](#)

Refueling

To ensure that you always have convenient access to all essential information when you stop for fuel, we recommend that you take the time to fill out the adjoining chart by entering the data that apply to your vehicle. Consult the index for individual specifications.

Fuel

Designation	
-------------	--

Please enter your preferred fuel here.

Engine oil

Quality	
---------	--

The space between the two marks on the dipstick corresponds to approx. 1.4 US quarts (1.3 liter).

Tire inflation pressures

	Summer tires		Winter tires	
	Front	Rear	Front	Rear
Up to 4 persons				
5 persons or 4 plus luggage				

More about BMW

bmwusa.com



The Ultimate
Driving Machine

M3 Coupe US-En