

---

# Table of Contents

## ON-BOARD MONITOR AND NAVIGATION SYSTEMS

Subject	Page
<b>On-Board Monitor</b> . . . . .	2
On-Board Monitor System Introduction . . . . .	2
Components, Locations and Removal Information . . . . .	4
On-Board Monitor and Navigation system interfaces . . . . .	7
On-Board Monitor Controls and Indicators . . . . .	8
Screen Samples of the On-Board Monitor Functions . . . . .	11
<b>Wide Screen Board Monitor</b> . . . . .	15
Introduction. . . . .	16
Component Overview. . . . .	17
Principle of Operation. . . . .	20
Workshop Hints. . . . .	20
<b>Mark I Navigation System</b> . . . . .	23
Global Positioning System (GPS). . . . .	24
Navigation System Inputs. . . . .	27
Mark I Navigation System Operation . . . . .	30
Mark I Navigation System Calibration Overview . . . . .	35
• Vehicle Owner Calibration . . . . .	35
• Dealership Calibration Procedures . . . . .	38
Mark I Navigation System Software Loading . . . . .	50
Mark I Diagnosis and Troubleshooting . . . . .	51
<b>Mark II Navigation System</b> . . . . .	53
Mark II Navigation System Introduction/ Component Locations . . . . .	54
On-Board Monitor and Mark II Navigation System Interface . . . . .	58
Mark II Navigation Diagnosis Mode Displays . . . . .	60
Mark II System Calibration . . . . .	63
Mark II System Diagnosis . . . . .	63
<b>Mark III Navigation System</b> . . . . .	64
Purpose of the System. . . . .	65
System Components. . . . .	66
Workshop Hints. . . . .	72
<b>Review Questions</b> . . . . .	77

---

## **ON-BOARD MONITOR SYSTEM**

**Model: E38, E39, E53, E46**

**Production Date: E46 1999 to 2002, all others 1997 to 2001.**

### **Objectives**

After completing this module you should be able to:

- Describe the controls possible from the On-Board Monitor.
- Explain the purpose of the ARCNET.
- Know how to operate the various features controlled from the On-Board Monitor.

## ON-BOARD MONITOR SYSTEM

The **On-board Monitor System** was introduced as **optional** equipment on the 1997 MY E38s and E39s. It was made standard on the E38 750iL for 1999 and standard for all E38s in 2000. It uses the latest advances in electronic technology to bring new levels of comfort and convenience to the driver and passengers for control of the audio/communication systems. In addition the **Mark I Navigation system is incorporated** into the total scope of On-board Monitor Control.

**NOTE:** The E39 six cylinder models with the On-board Monitor option are equipped with the high version IKE and On Board Computer functions.

The On-board Monitor is essentially a control and display unit. All data processing and calculations are carried out by the individual system control modules. The display data is sent to the On-board Monitor over the various interfaces.

The On-board Monitor is mounted in the center dash console. It replaces the Radio/Tape Player, MID and DSP control panel (E38) if equipped.

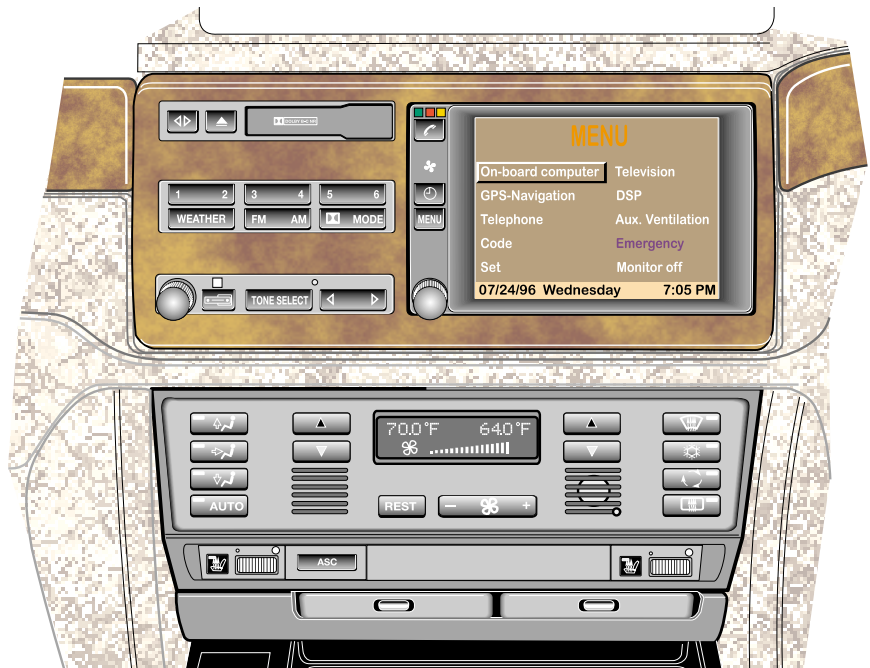

It consists of control knobs and buttons for programming and operating the various systems.

There is a 5 1/4 inch, color LCD screen for display of all system functions. The tape player drive is also part of the On-Board Monitor unit. However, the radio receiver/amplifier module is now mounted in the trunk. The audio system is controlled from the on-board monitor. Additionally, the systems controlled and programmed through the On-board Monitor include:

- On Board Computer
- Navigation system
- Telephone
- Code Function
- Set (on-board monitor setup)
- Television (Early production only)
- Digital Sound Processor (DSP)
- Auxiliary Ventilation
- Emergency (provides vehicle location and automatically dials telephone for help).
- Monitor Off (Switches the monitor off).

## COMPONENTS

### ON-BOARD MONITOR ASSEMBLY

The on-board monitor assembly is mounted in the center console. It consists of the following components:

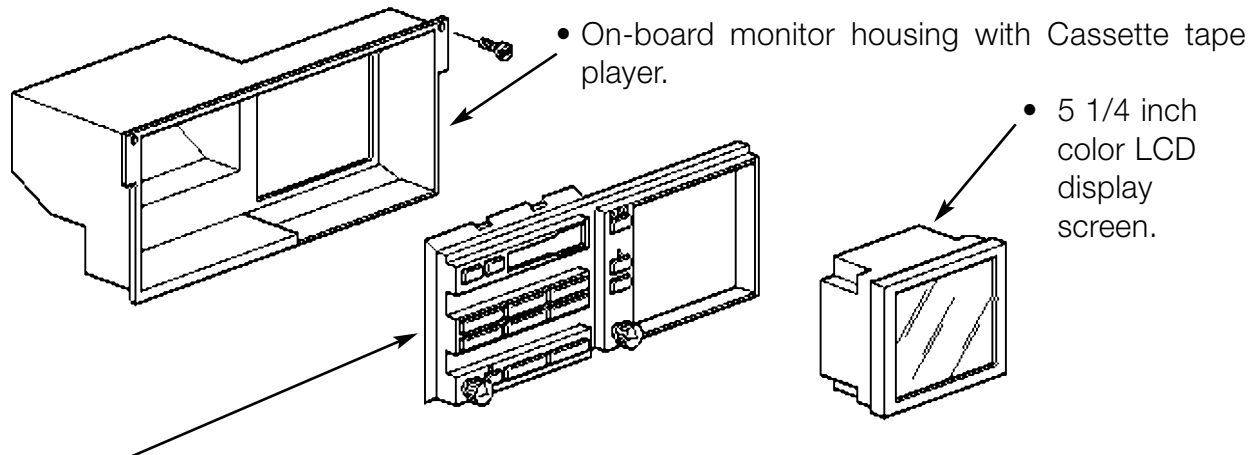

- **BMBT.** BMBT is a German acronym meaning, "Board Monitor Bedien Tiel". Translated to English this means On-Board Monitor Control Module/Panel. The BMBT is connected to the I-BUS. It provides the same function as the pushbutton inputs and output illumination of the LEDs of the familiar MID.

### REMOVAL OF ON-BOARD MONITOR ASSEMBLY FROM CENTER CONSOLE

The on-board monitor is removed from the center console as an assembly as follows.

1. Remove the wood trim from the dash on both sides of the on-board monitor.
2. Unscrew the metal plates (E38) or unhook the latches (E39) from each side of the on-board monitor and loosen the recessed screw from the lower edge of the wood trim.
3. Remove the on-board monitor wood trim
4. With the on-board monitor wood trim removed, unscrew the four large torx™ screws as shown.
5. Pull the on-board monitor assembly out of the center console.

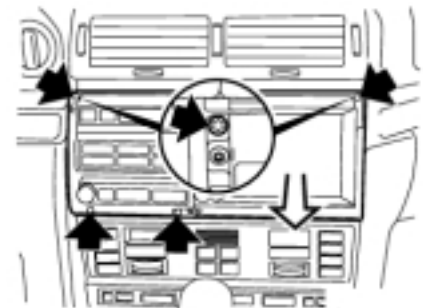

**For complete procedures refer to group 65 repair manual in TIS.**

The following components are mounted in the trunk on the left side behind the trim cover

**Mark I  
NAVIGATION  
COMPUTER  
MODULE**

It contains a micro-processor and CD drive for navigation system operation.

The navigation computer is linked directly to the video module which provides the visual and audio output instructions for the navigation system.

**AUDIO SYSTEM  
AMPLIFIER**

**RADIO  
RECEIVER**

**AUDIO SYSTEM  
CD CHANGER**

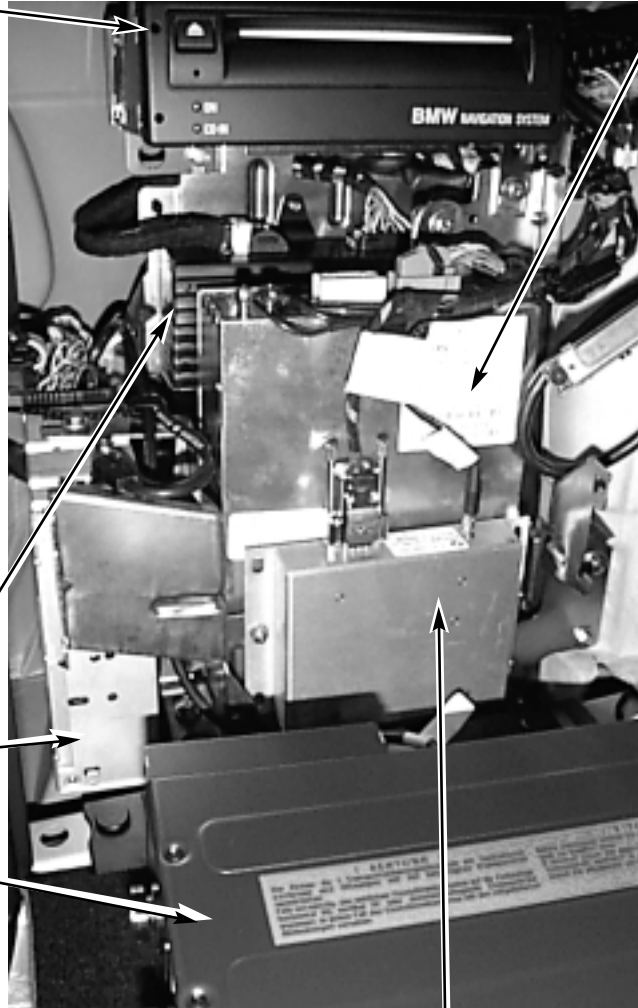

**VIDEO MODULE**

The video module generates the Red, Green and Blue video signals for the on-board monitor LCD screen. The RGB signals are for all functions of the on-board monitor including the nav. system.

The video module also serves as a data memory for the navigation system. As needed the video module instantly provides the RGB signals to change the on-board monitors display and sends the audio signals to the audio system amplifier.

**GLOBAL POSITIONING RECEIVER MODULE (GPS)**

The module determines the exact position of the vehicle from known orbits of GPS satellites. The GPS receiver interfaces with the Navigation computer module for determining the vehicle position.

**NAVIGATION COMPUTER REMOVAL:**

To remove the nav. computer from the mounting bracket insert four small phillips head screwdrivers into the four holes on the face plate. Push the screwdrivers in past a slight detent. Pull the nav. computer out of the mounting bracket.



INSERT A SMALL  
PHILLIPS HEAD  
SCREWDRIVER INTO EACH HOLE

**The following components are located on the rear parcel shelf under the trim panel.**

**MAGNETIC FIELD SENSOR**

The magnetic field sensor is a small micro processor. It is used while the navigation system is operating to determine the vehicle's direction of travel.

**GLOBAL POSITIONING RECEIVER ANTENNA**

The antenna picks up the signals from the satellites and transmits them to the GPS module.

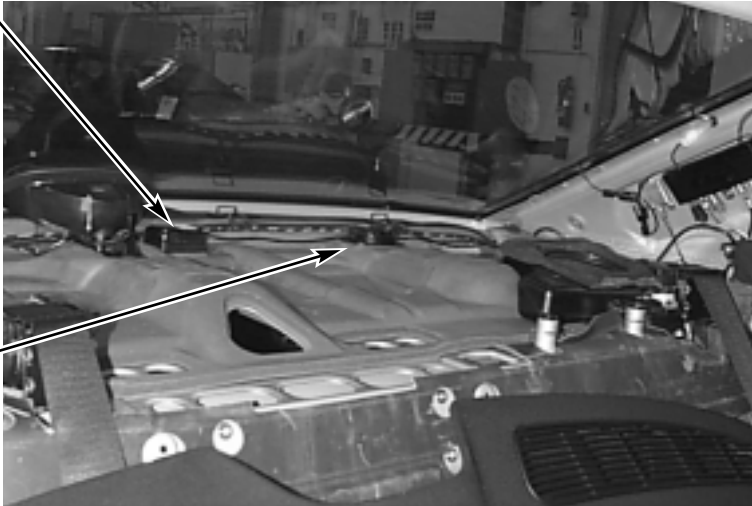

**Carry over components that are part of the On-Board Monitor / Navigation system include:**

- Instrument Cluster Control Module (IKE) for On Board Computer calculations
- Multi-Function Steering Wheel (MFL) for radio and telephone control functions.
- Telephone handset for operation of the phone.
- ASC control module for the two front wheel speed sensor inputs.

---

---

---

---

---

---

---

---

---

---

## ON-BOARD MONITOR AND NAVIGATION SYSTEM INTERFACES

**I BUS** - The On-board Monitor Control Module/Panel is connected to the I-Bus for communication with the other I-Bus components. Data communication takes place over the I-Bus between the BMBT and the following modules:

- IKE
- Telephone Handset
- Multi-Function Steering Wheel (MFL)
- Radio Receiver
- Video Module
- Audio System Amplifier

**ARCNET** - The **A**ttached **R**esource **C**omputing **N**etwork is a high speed (2 MB/sec) digital data link. The Navigation Computer and Video Module are connected by the ARCNET for isolated high speed navigation system communication.

The ARCNET is made up of two data wires and a shield similar to the familiar CAN data link. The shielded ARCNET cable has its own triaxial type connector ends that are pushed onto their mating connectors on the modules.

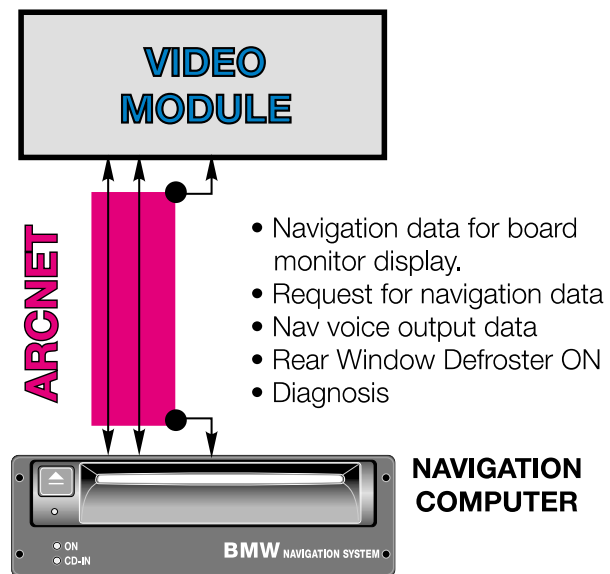

**Video Module Red, Green Blue (RGB) output** - The On Board Monitor is connected to the Video module through the RGB connection for the LCD screen displays. Each of the three color signals is shielded.

---

---

---

---

---

---

---

---

---

---

---

---

---

---

---

---

---

---

---

---

---

---

---

---

---

# ON-BOARD MONITOR CONTROLS & INDICATORS

## AUDIO SYSTEM

Operation of the audio system (radio/tape/CD) is similar to current systems installed in other models. The major difference is that the display of stations and settings is through the LCD panel.

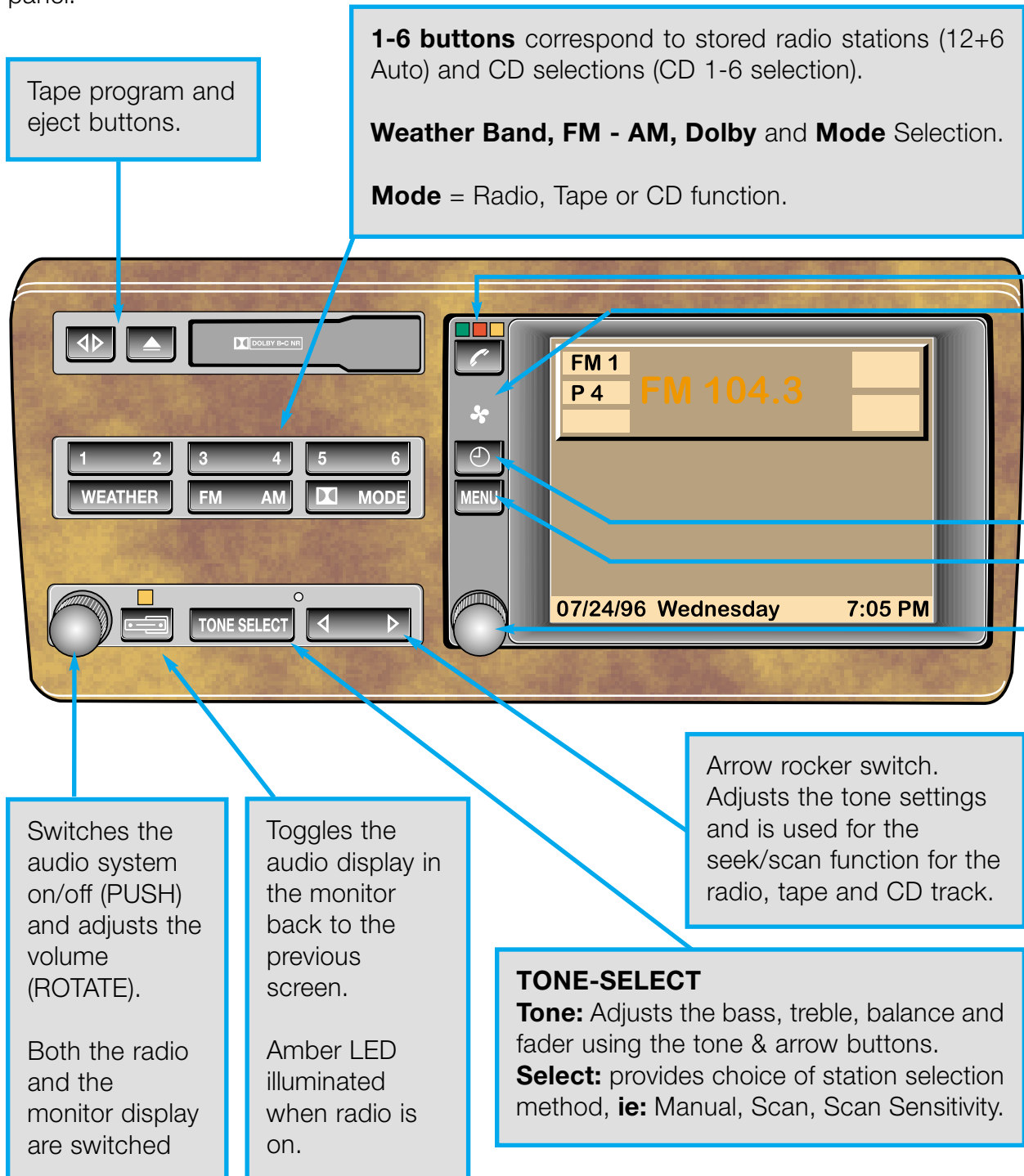



## TELEPHONE BUTTON AND INDICATORS

**Send/End button.** As on previous systems this button sends the call to the displayed telephone number in the On-Board Monitor display or ends the current call.

The telephone LEDs correspond to the E38/E39 MID:

**Green** = Phone call in progress

**Red** = Phone is on

**Amber** = Steady: Roaming in same type system as home system

Flashing: Roaming in different type system as home system

**Fan Symbol:** Flashing indicates the park car ventilation system is programmed for activation. Steady indicates the parked car ventilation is currently on.

**Clock Button:** Displays the time with the key switched **OFF**. Additionally, this button also switches the parked car ventilation system to off when it is on.

## ON SCREEN CONTROLS

There are two main controls for all of the monitor screen displays.

### MENU BUTTON

The menu button is used to call up the Main Menu as shown at right.

This Menu provides access to all of the On-Board Monitor functions including:

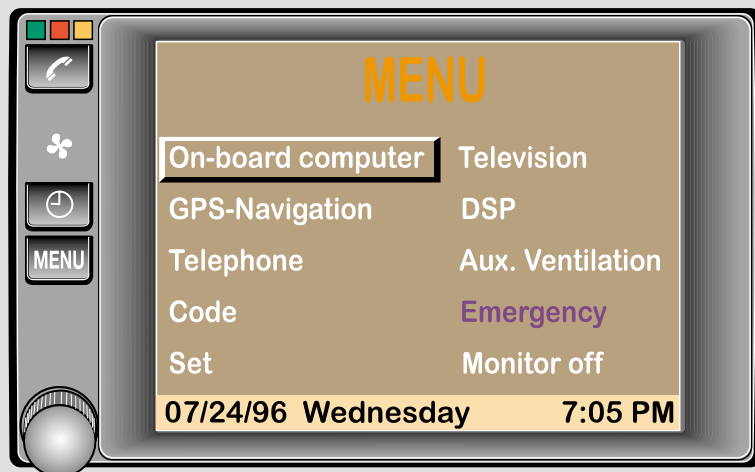

### ROTARY KNOB

**PUSH** = Switches the monitor on or activates the selected program displayed in the monitor.

**ROTATE** = Selects the desired function for programming or display

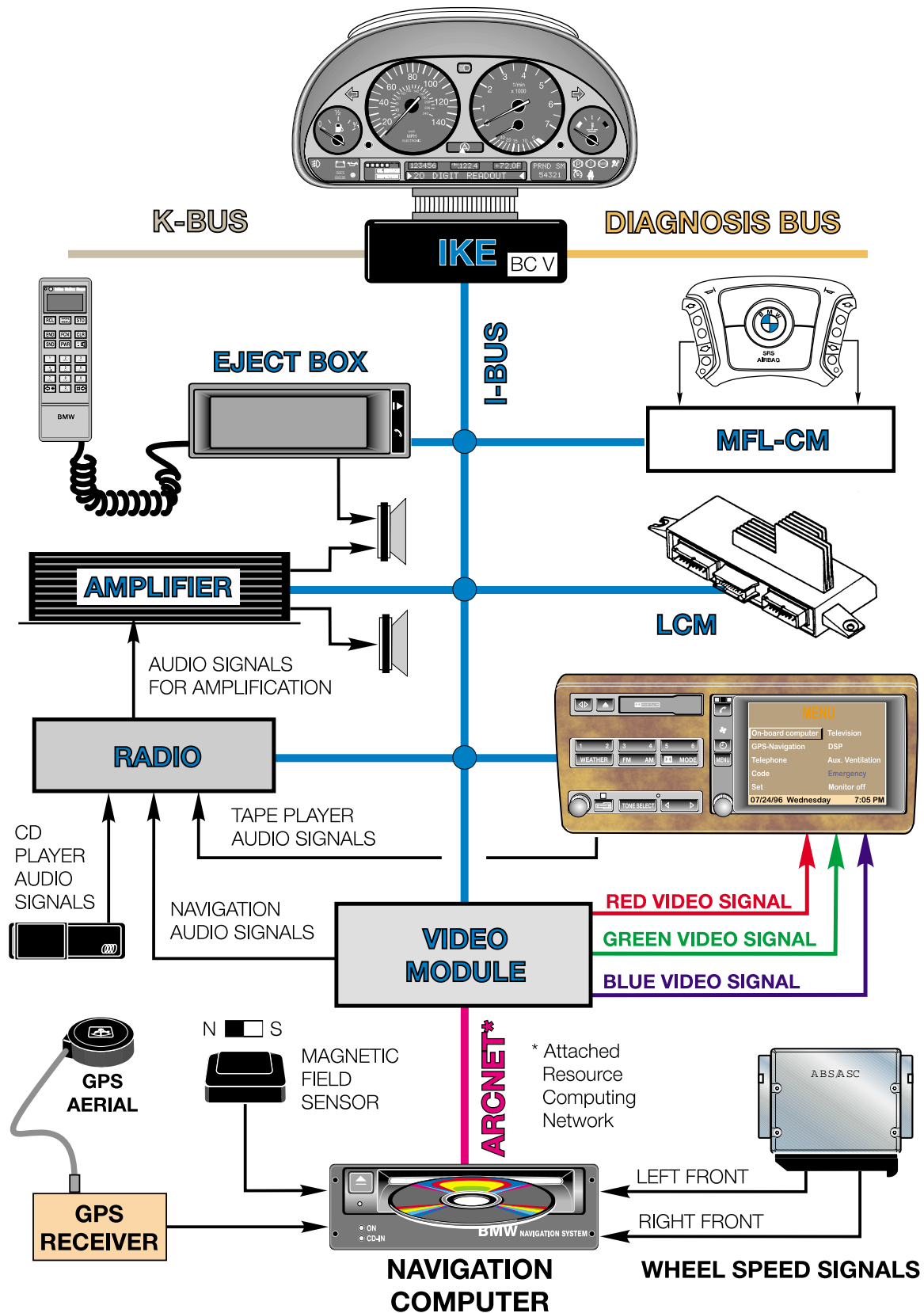

## SCREEN SAMPLES OF THE ON-BOARD MONITOR FUNCTIONS

### ON BOARD COMPUTER

The functions of the On Board Computer remain the same as previous systems. All On Board Computer calculations are still performed by the IKE.

The OBC is called up from the On-board Monitor main menu by highlighting the BC and pressing the knob.

Once the computer functions are displayed, all programming and resetting of the displays is carried out using the rotary knob.

---



---



---



---



---



---

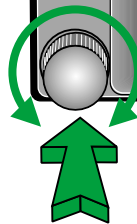
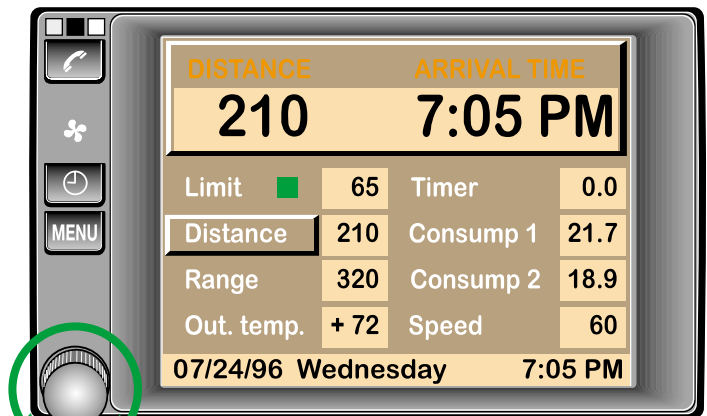
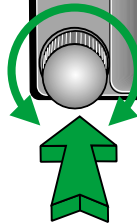
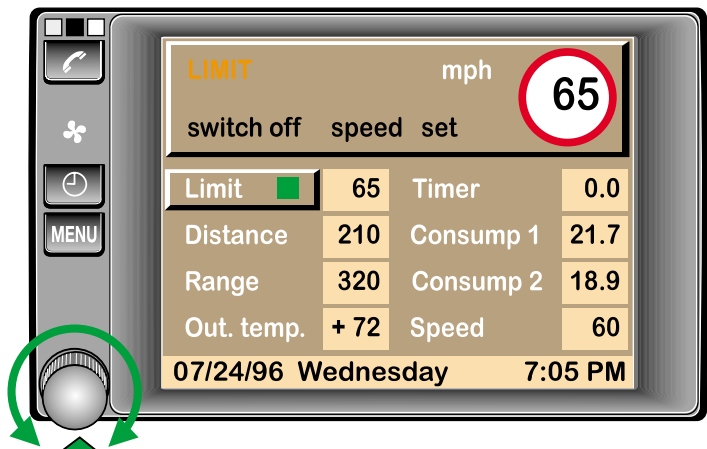

### MARK I GPS NAVIGATION

The on-board monitor provides access to the new Navigation system.

The Mark I Navigation system is controlled and displayed via the on-board monitor.

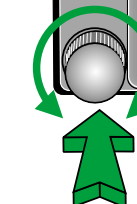
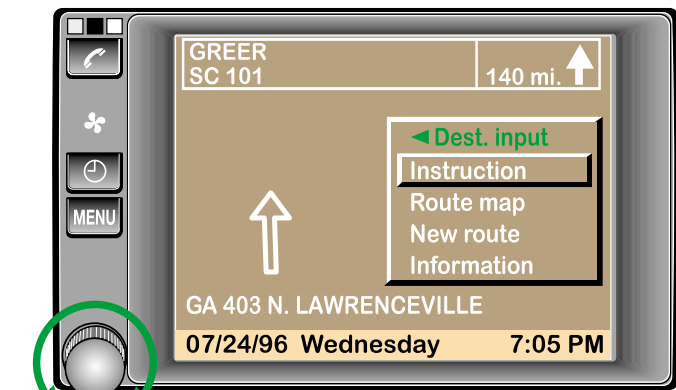

## TELEPHONE

Selecting the Telephone function on the Monitor screen will call up a rotary dial display. The telephone can be dialed with the rotary knob by turning the knob and pressing it when the desired digit is highlighted. Once the number is input, the call is initiated by pressing the send/end button at the left of the Monitor.

All telephone programming is carried out through the handset as on other telephone models.

Other features of the monitor telephone control include:

- Memory storage and recall
- Information on signal strength and call timer
- Top 8 number storage
- Emergency call feature
  - Displays 911 or Assist.
  - Displays the vehicles current coordinates in latitude and longitude along with the street name (if the street is on the digitized map database).

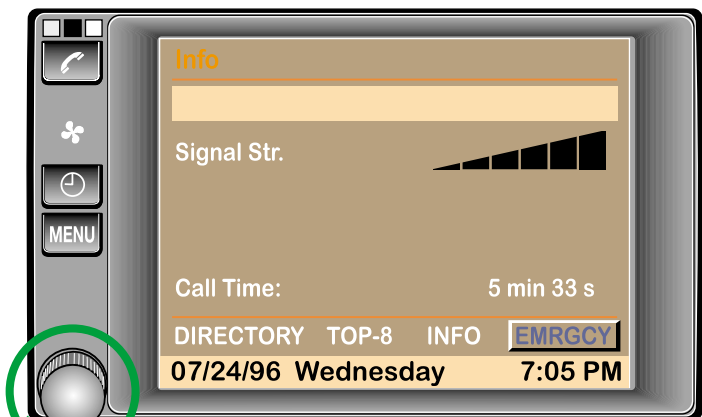
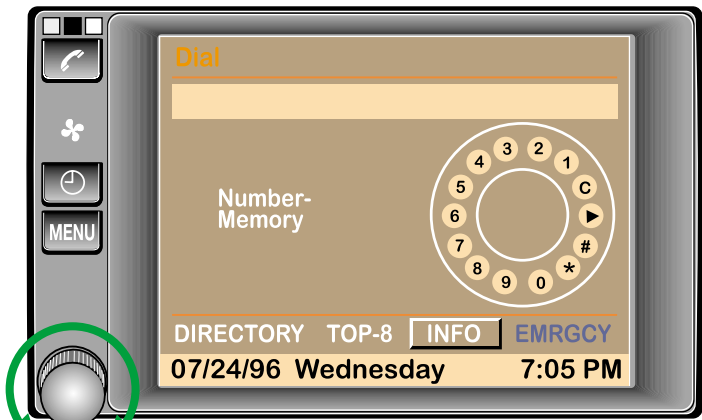

## CODE FUNCTION

The familiar BC code function is carried over to the On-board Monitor system. A four digit code can be entered into the system that will disable the vehicle from starting as with previous systems.

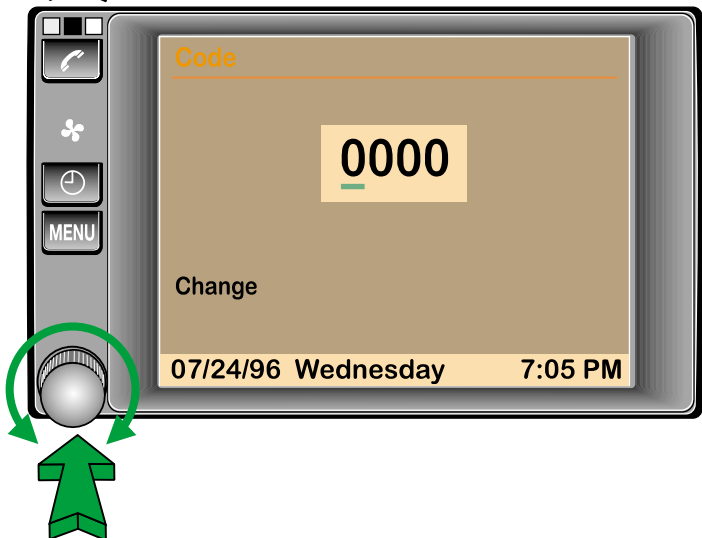

## SET (On-Board Monitor Setup Utility)

The Set Menu provides the on-board monitor display set up. This includes:

- Language Selection
- Time/date set and format
- Etc.

The “Audio+BC” selection at the bottom of the list switches the BC display off when the audio display is in the monitor.

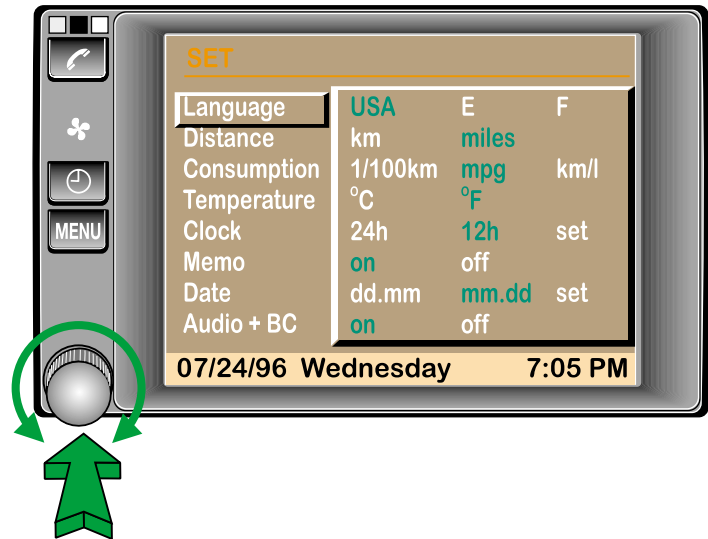

## TELEVISION

**Early production only!** The television function will be selectable from the main menu. Though audio is heard, television images will not display in the On-board Monitor.

**E38:** vehicles are prewired for television viewing in the rear seat. A TV monitor connector is located in the rear of the center console for this purpose. This is only possible with owner purchased equipment. The On-board monitor will only serve as the controller for rear seat television.

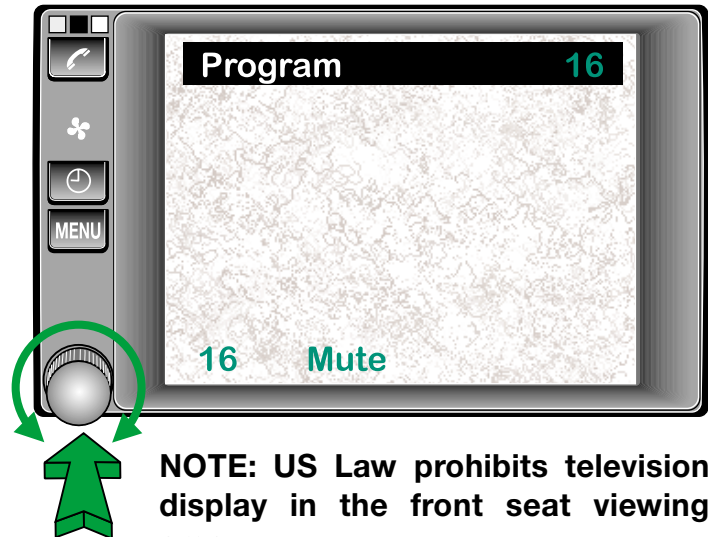

**NOTE: US Law prohibits television display in the front seat viewing area.**

## DIGITAL SOUND PROCESSOR (DSP)

The DSP system, introduced with the E38 is controlled and programmed through the On-board Monitor.

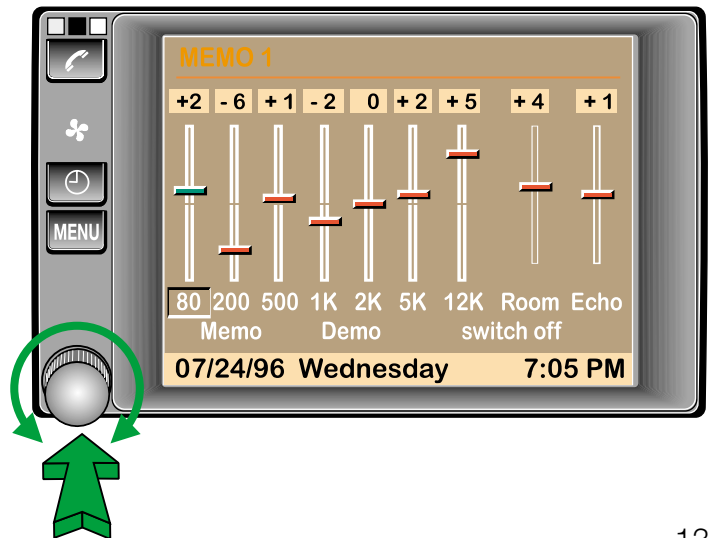

## AUXILIARY VENTILATION

The control and programming of the auxiliary ventilation feature is done with the on-board monitor. Use the rotary knob to program the on times for system operation.

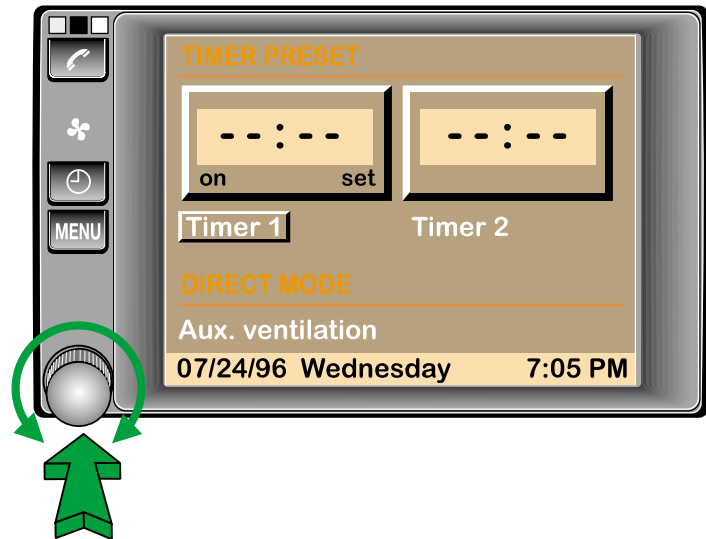

## EMERGENCY

The Emergency function provides the exact location of the vehicle including:

- Street and Town (if on digitized map)
- Longitude and Latitude Coordinates

If the vehicle is equipped with a telephone, 911 or Assist (BMW roadside assistance) can be called directly from this screen.

If the vehicle is not equipped with a phone the emergency program provides your location.

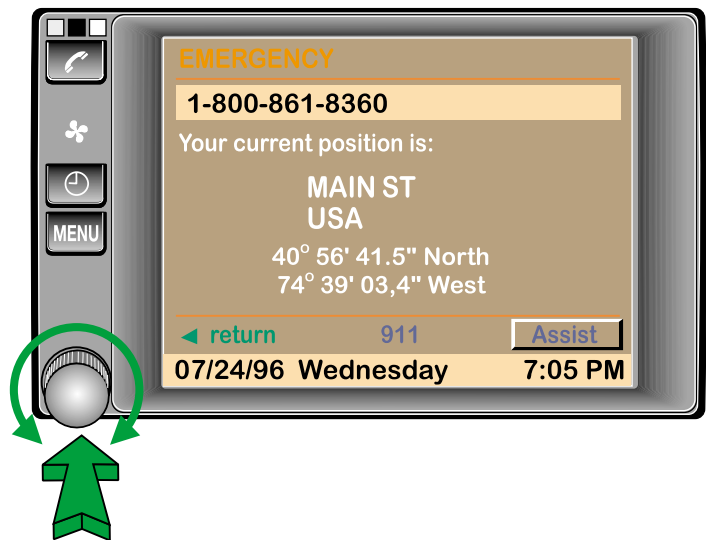

## MONITOR OFF

Pressing the "Monitor Off" button switches the monitor to a blank screen. All programs are still functioning but not displayed in the monitor. The monitor is turned back on by pressing or turning any button on the on-board monitor.

---

## **WIDE SCREEN ON-BOARD MONITOR**

**Model: E39,E38,E46,E53**

**Production Date: E38,E39 from 9/00  
E53 from 1/01  
E46 Cabrio from 3/01  
all other E46 models from 9/01**

### **Objectives**

After completing this module you should be able to:

- Describe the benefits of the wide screen monitor over the previous versions.
- Understand how to operate the wide screen monitor.
- Review the procedures to access the Service Modes.

## Introduction

While the instrument cluster provides all of the important vehicle status information to the driver, the on-board monitor is designed as an additional display that can be viewed by both the driver and vehicle passengers. Information relating to the vehicle, navigation, audio system and telephone can be displayed and controlled from a central location.

The wide screen on-board monitor replaces both the 5.5" versions in the E38 and E39, and the 5" board monitor from the E53 and E46. The wide screen display has a screen size of 6.5" and an aspect ratio (length:height) of 16:9.

### The benefits of the wide screen design are:

- Larger display area and higher resolution (400X234 pixels).
- Improved display screen technology (Ad-TFT LC).
- Bigger text size.
- Soft keys replace country specific audio function keys.
- Used for all board monitor applications in all markets reducing variants.
- Larger display area makes split screen and magnification features possible (future software enhancements).





---

## Component Overview

The wide screen on-board monitor consists of:

1. Monitor housing with cassette drive
2. Display screen
3. On-board monitor control panel

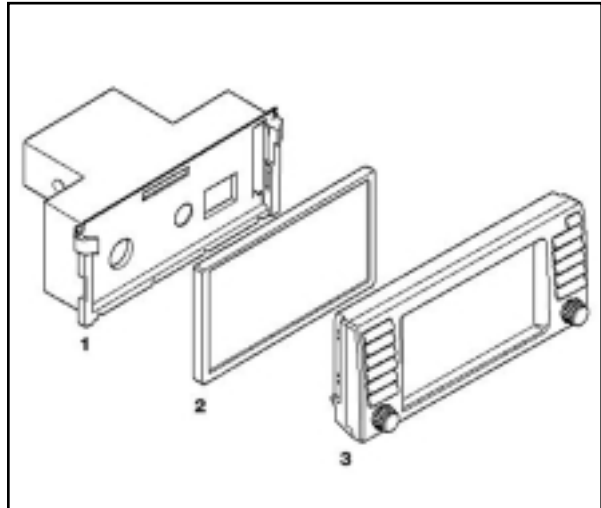

### Cassette Drive

The cassette drive is located behind the on-board monitor screen. In order to access the cassette, press the “eject” button, the display screen tilts forward to uncover the cassette slot. The images will remain displayed on the screen.

After pressing the “eject” button again or automatically after 15 seconds the display returns to its normal position (cassette must be completely inside or removed). The tilt mechanism for the display screen utilizes anti-trap, if the board monitor detects a sudden change in speed, the display will reverse direction.



## Display Screen and Control Panel

The display screen has a diagonal width of 6.5" and an aspect ratio of 16:9 compared to the previous monitors that had a ratio of 4:3. The new screen also uses a Ad-TFT display (Advanced Thin Film Transistor). This type of screen uses ambient light in addition to back-lighting in order to illuminate the display. The advantage is a constant contrast and brightness level at all ambient lighting conditions.

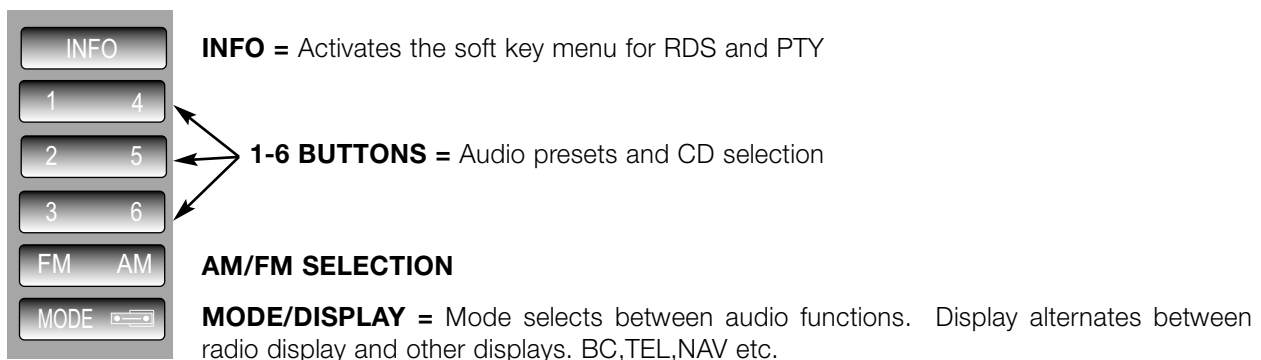
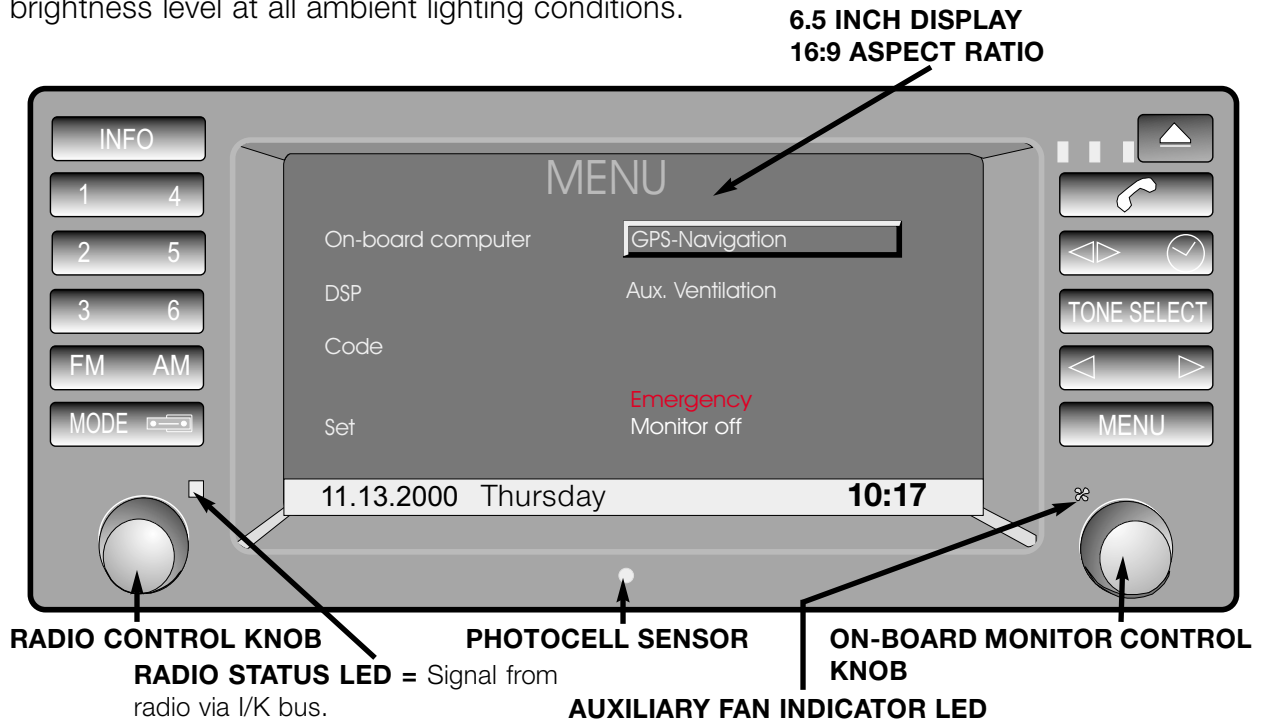

**TELEPHONE STATUS LEDs / EJECT** = Tilts monitor to access cassette drive.

**TELEPHONE** = Send/End button

**TAPE REVERSE/CLOCK** = Clock: Pressing with key off displays time. Aux. ventilation can be switched by holding button longer.

**TONE/SELECT=Tone:** Dolby (cassette only) and audio adjustments.  
**Select:** Choose between station search methods (a,m or scan).

**FAST FORWARD/REVERSE / STATION SEARCH**

**MENU** = Returns display to main menu



# Wide Screen Board Monitor Interface

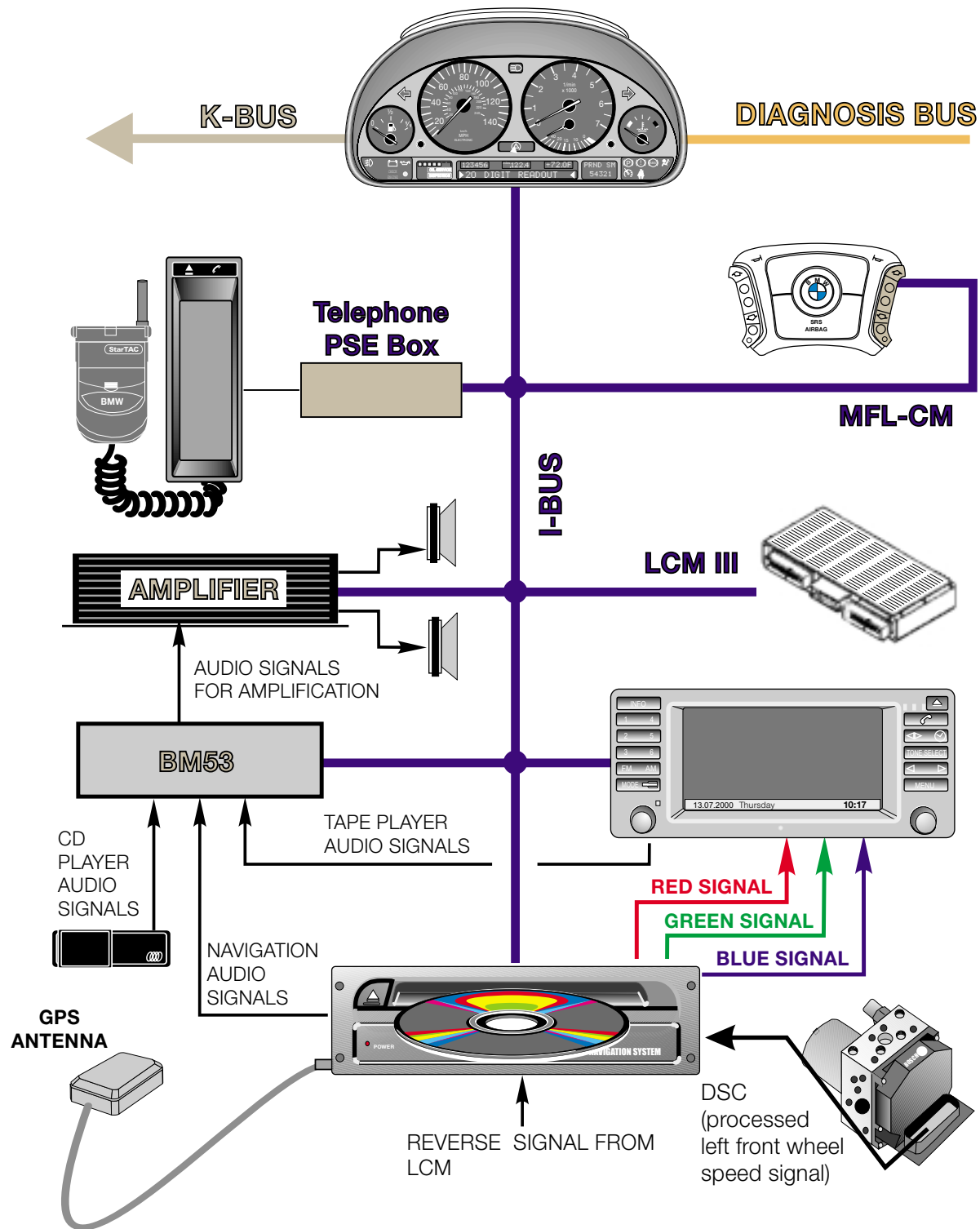

Example of E38/E39 with Wide Screen Board Monitor

## Principle of Operation

The on-board monitor is an input and display device that performs no internal calculations.

Inputs from the control panel buttons and knobs are converted into I-bus (K-bus E46) signals by the BM control panel. All of the devices controlled by the BM are connected to the I/K bus interface.

The navigation computer contains the graphics stage integrated into the navigation computer housing. Request for on-board monitor displays are made to the navigation computer via the I/K bus. The navigation computer generates the RGB video signals and transmits them via 3 shielded wires.

Audio signals generated by the cassette drive are sent via traditional audio wires (4) to the radio (located in the trunk or cargo area) for output to the audio system amplifier.

## Workshop Hints

### Service mode

Access for the radio, on-board monitor and navigation service modes is available through the on-board monitor screen.

#### To enter the radio service mode:

- Turn the ignition key to position 1 (KLR).
- Turn the radio on, then off, then on again.
- Press the “INFO” button. From the selection list choose “RDS”.
- Press and hold the on-board monitor control knob for at least 8 seconds.
- The audio display window will show the radio serial number as the first display.
- The station search < > buttons are used to scroll through the various settings.
- Turn off the radio to “set” any changes made.

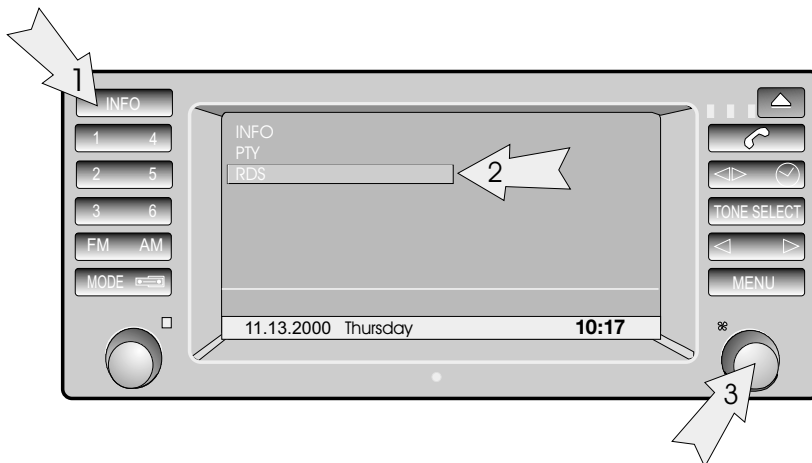

**Note: See the “NG” Radios module for a list of the tests and settings available in the radio service mode.**

### To enter the On-Board Monitor and Navigation Service Mode:

- Turn the ignition key to position 1 (KL R).
- From the Menu screen select “SET”.
- Once in the Set screen, press and hold the “MENU” button for 8 seconds.
- The Service Mode menu will appear on the display.
- Select “On-board monitor” for monitor specific tests.

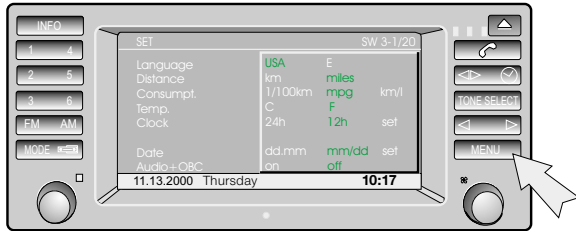

Press and hold for 8 seconds after entering the “SET” screen.

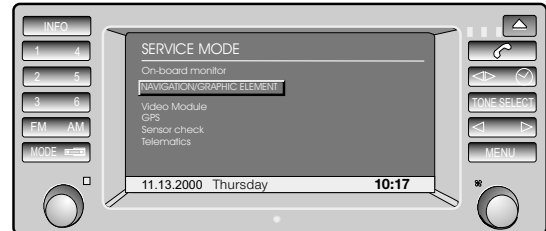

Service Mode main menu display

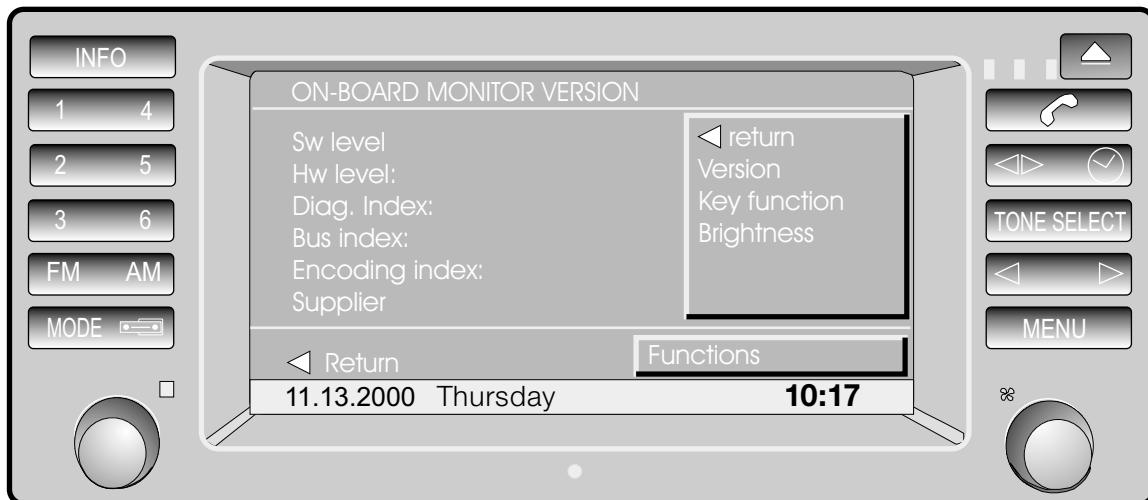

Tests and adjustments available for the on-board monitor are:

- Version Information
- Key Function (button and rotary knob test)
- Brightness (Screen brightness adjustment)

---

## Diagnosis

Fault driven diagnosis is possible using the DIS/MoDiC Diagnosis Program. The Diagnosis Program features:

- Identification
- Read/Clear fault memory
- Diagnosis requests
- Fault driven test modules. (E46 concept)

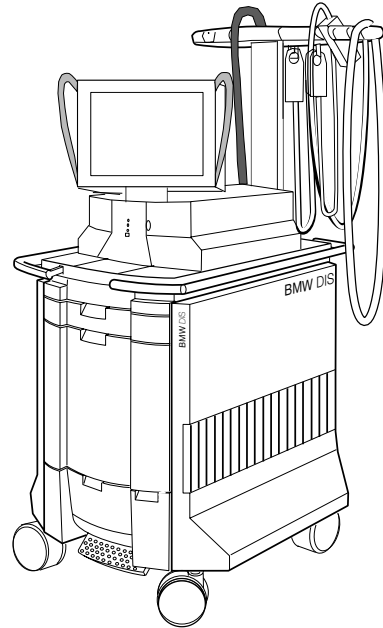

---

## **Mk-1 NAVIGATION SYSTEM**

**Model: E38, E39**

**Production Date: 10/96 to 9/97**

### **Objectives**

After completing this module you should be able to:

- Understand the principles of GPS Navigation.
- List the components used in the Mk-1 system.
- Recognize the reasons that would require a system calibration.

# GPS - NAVIGATION SYSTEM

## GLOBAL POSITIONING SYSTEM (GPS)

The BMW Navigation system operates in conjunction with the Global Positioning System (GPS). Utilization of the GPS improves the accuracy and provides redundancy for the Navigation system which also incorporates a dead reckoning system. The GPS was designed by the US Government in the 1970s for military purposes. In recent years it has been made available for civilian use.

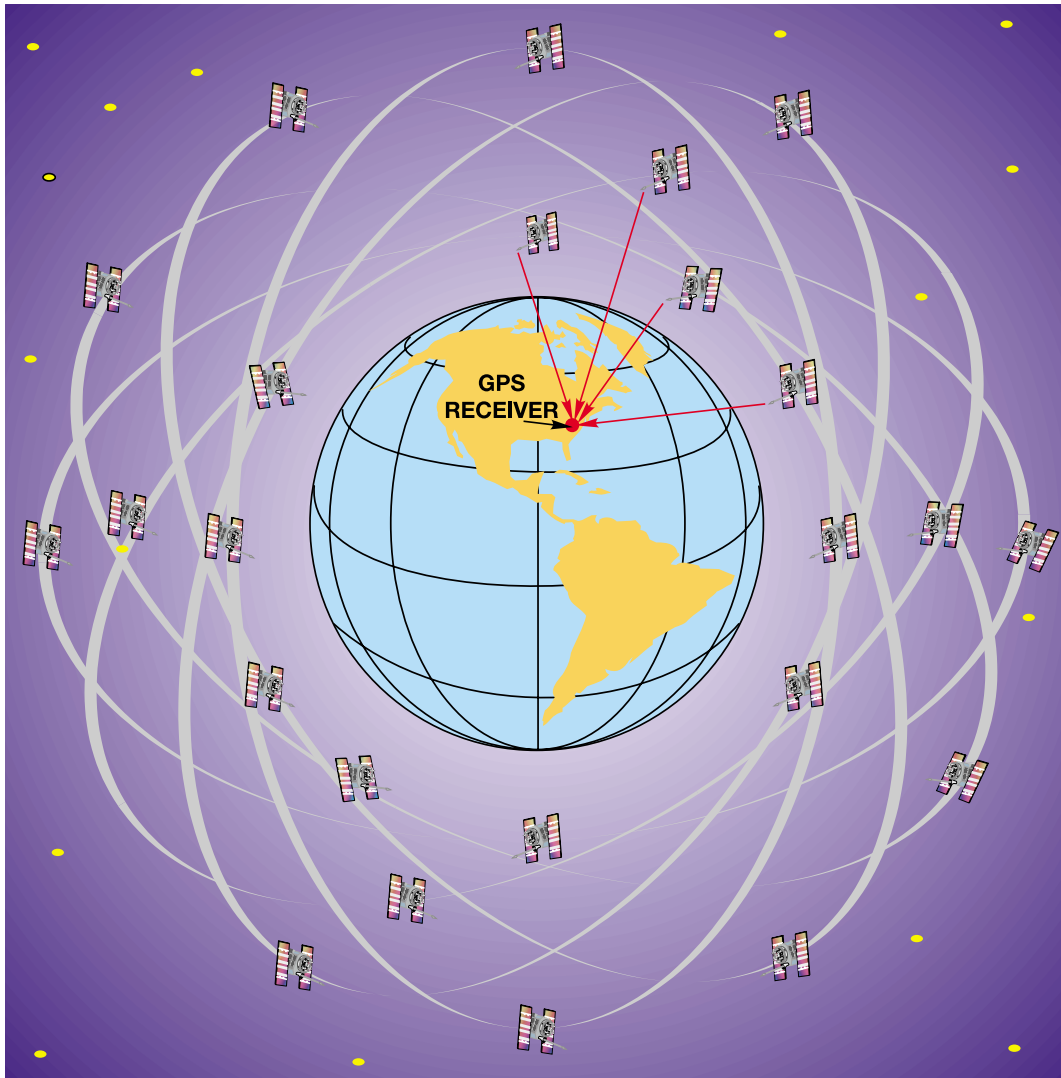

There are 24 satellites equally divided among six orbits that are positioned 11,000 miles out in space. Each satellite continuously emits a radio signal. The signals contain short information messages including:

- The exact time the message was broadcast.
- Current latitude and longitude positions relative to the orbit.



A GPS receiver device on earth receives these signals from the satellites and determines its own location by:

- Comparing its internal clock signal with the satellites. This determines the distance from the satellites location.
- Through triangulation computation, the receiver module calculates its own longitude and latitude position. This is only possible when it receives a minimum of three satellite signals.

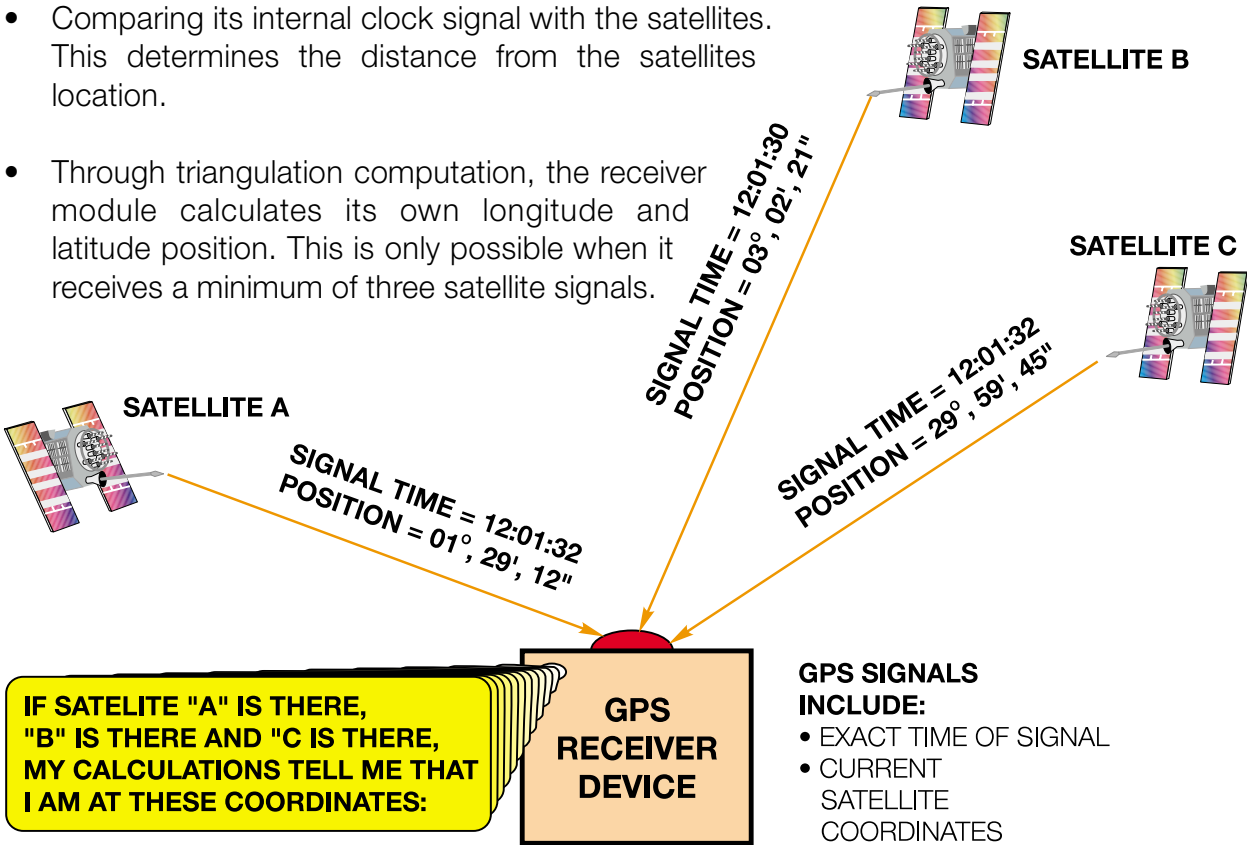

In a sense, GPS can be compared to navigation methods used by sailing ship navigators years ago. They used a sextant to plot the changing locations of known stars to determine their own position. This, in conjunction with compass navigation, proved an accurate method of sailing across the seas.

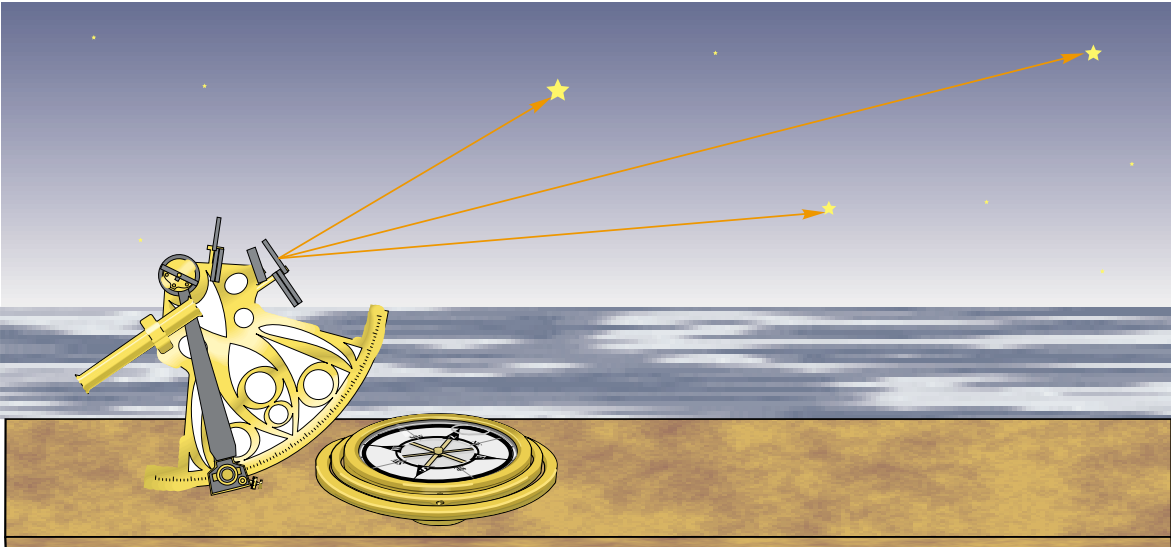

The BMW navigation system is based on the CARiN™ system developed by Philips Electronics. **CARiN™** = Car Information and Navigation System.

The BMW Navigation system is a CD driven, on board, active route mapping computer. The driver can enter a destination through the On Board monitor and the navigation system will select a mapped route, from the current location, to the destination.

The route maps are stored digitally on a navigational database CD that is installed in a dedicated CD drive in the navigation computer.

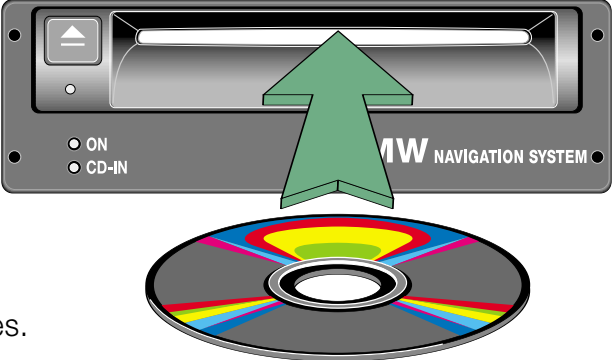

The U.S. is divided into 7 mapped CD database areas ranging from:

- Area 1 - California and Nevada, through
- Area 7 - Covering the South Eastern States.

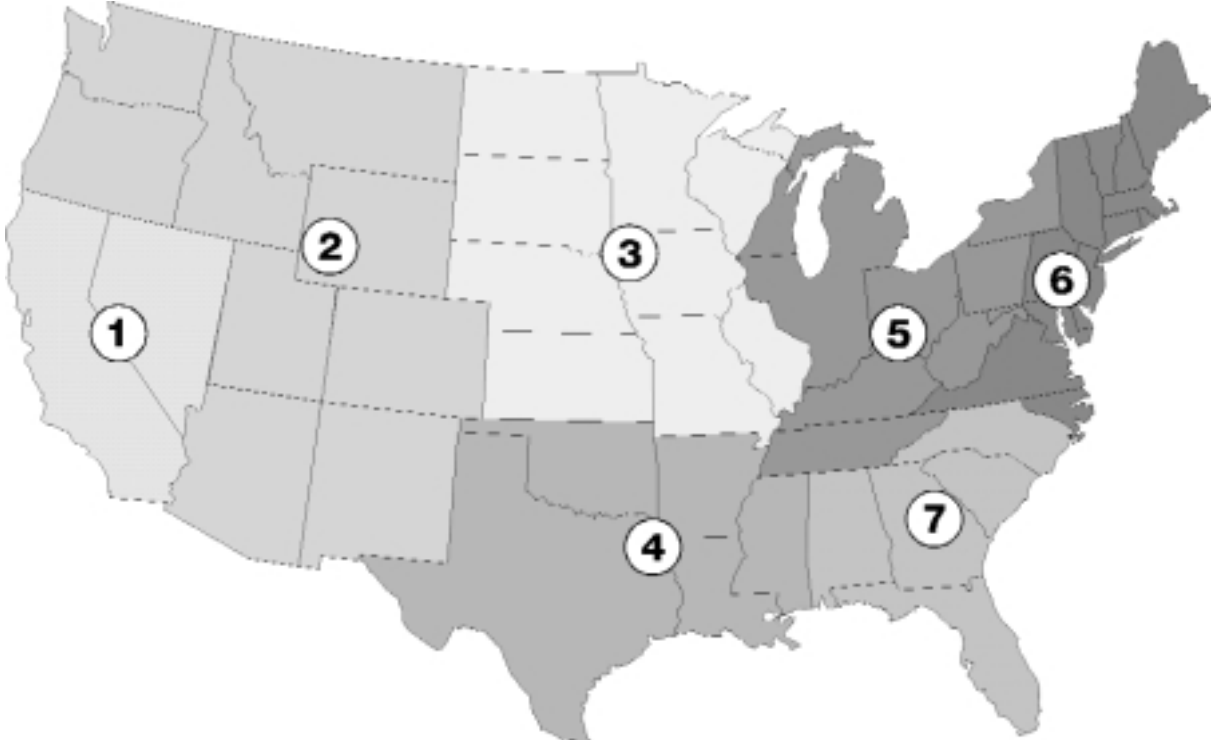

In addition to the digitized route maps, other information such as hotels, restaurants, service stations, dealerships, points of interest and local sight-seeing attractions along with their addresses are stored on the database CD.

The map CDs are currently being updated twice a year. As the updates occur, more streets and roads will be added. In addition, more local information will be added with regards to businesses, hotels, motels, local attractions, etc.

## MARK I NAVIGATION COMPUTER INPUTS

The Mark I Navigation computer relies on the digitized map CD data to calculate the routes to the selected destinations. The Nav. computer also relies on accurate input signals from the vehicle to calculate the exact coordinates of the vehicle at all times.

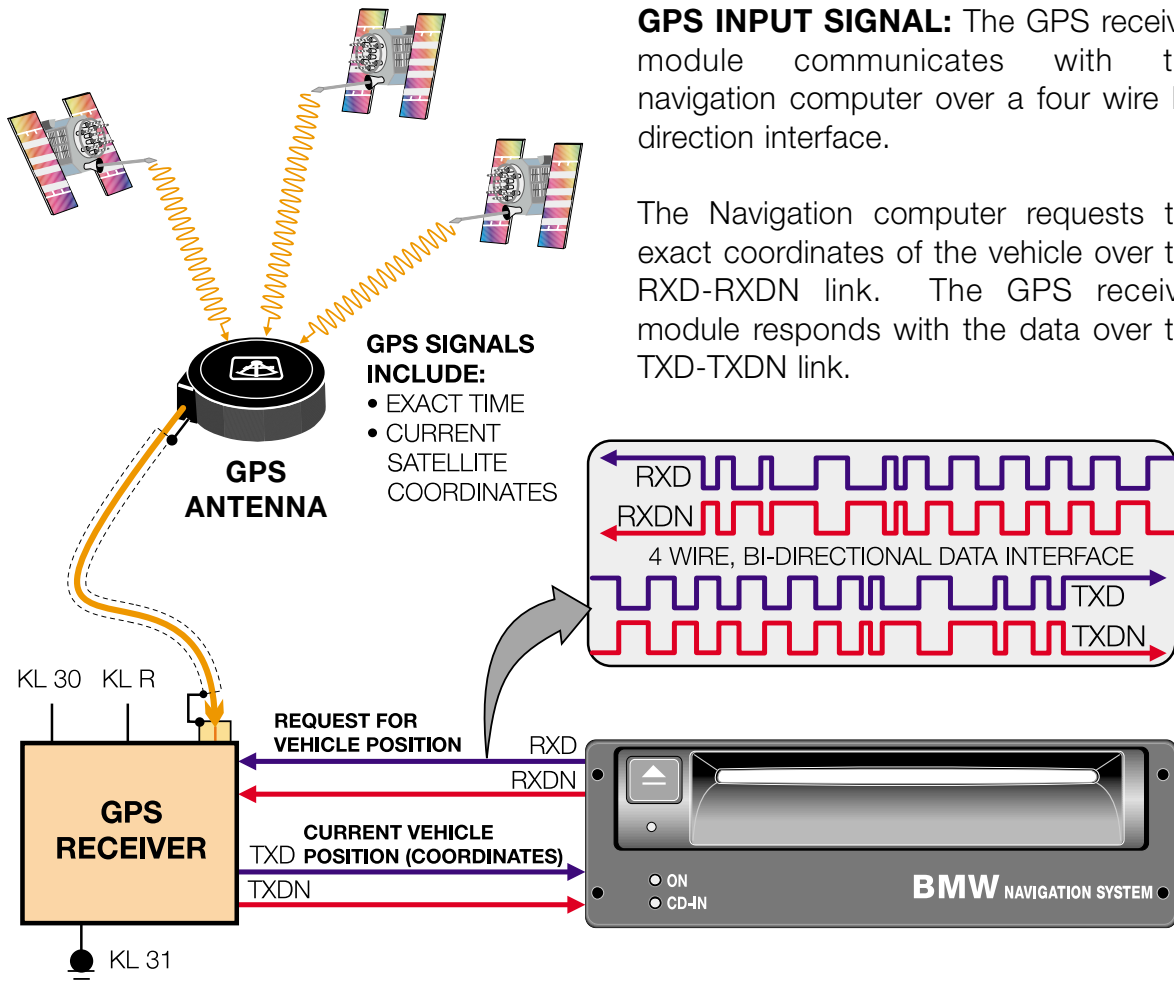

**GPS INPUT SIGNAL:** The GPS receiver module communicates with the navigation computer over a four wire bi-direction interface.

The Navigation computer requests the exact coordinates of the vehicle over the RXD-RXDN link. The GPS receiver module responds with the data over the TXD-TXDN link.

Each two wire link is similar to the CAN line signal but unidirectional. When a data burst is transmitted it is mirrored on the other wire as a self check of the data transmission.

The GPS receiver module is provided KL 30 to maintain vehicle position in memory. When KL R is switched on the receiver module resumes monitoring the satellite radio signals picked up from the GPS aerial. The link to the GPS antennal is a gold plated coaxial connector.

## MAGNETIC FIELD SENSOR

In addition to the vehicle's current position, the navigation computer also needs a direction of travel input. The magnetic field sensor is used for this purpose.

The sensor consists of a ferromagnetic ring with two coils of wire placed 90° apart. Signals from the two coils become the vehicle's directional input when the navigation system is in operation.

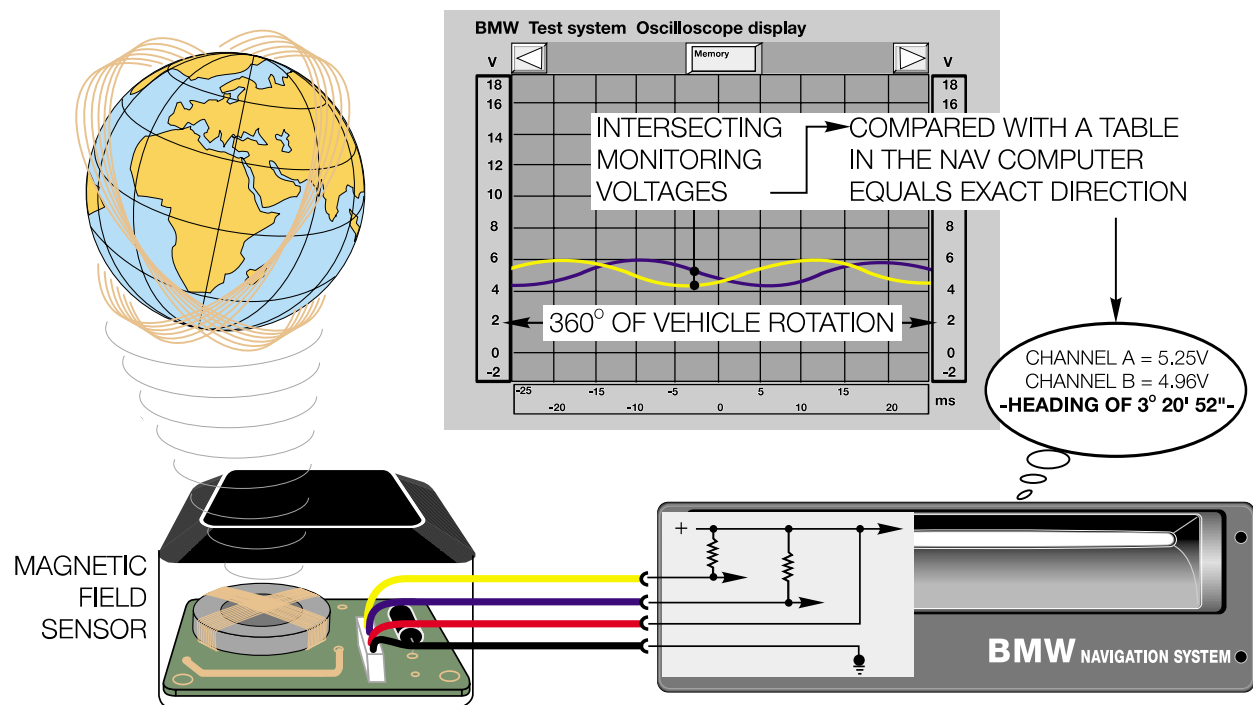

## SENSOR OPERATION

The sensor receives its operating power and ground from the navigation computer. When the system is switched on, magnetic fields are induced into the coils. The coils produce a voltage signal that is input to the navigation computer.

As the vehicle turns to the left or right, the earth's magnetic field influences the coil's magnetic fields causing them to increase and decrease.

The changing strength of the magnetic fields causes the voltage signal induced in the coils to increase and decrease linearly. This creates a changing voltage drop at the monitor in the navigation computer.

The navigation computer determines the direction of travel of the vehicle by plotting the simultaneously changing voltage signals.

## FRONT WHEEL SPEED SENSORS

The navigation computer is provided with the front wheel speed signals to track the vehicle speed/distance and turning.

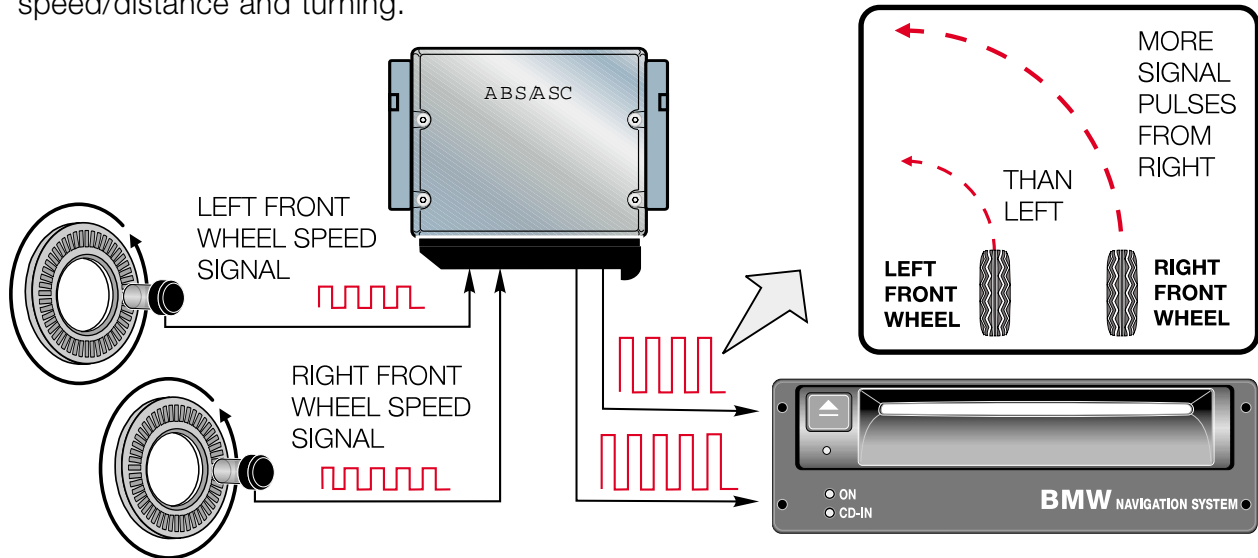

## REVERSE GEAR SELECTED

The nav. computer receives a 12 volt signal from the LCM when the back up lights are illuminated. This signal informs the nav. computer that the vehicle is being driven in reverse.

## REAR WINDOW DEFROSTER ON SIGNAL

When the rear window defroster is switched on the nav. computer is informed via the vehicle bus system:

- IHKA to the IKE (Kbus)
- IKE to video module (Ibus)
- Video module to the nav. computer (ARCNET)

When the nav. computer receives the signal, it compensates for the magnetic influence from the rear defroster.

This compensation is derived from the dealership calibration procedure.

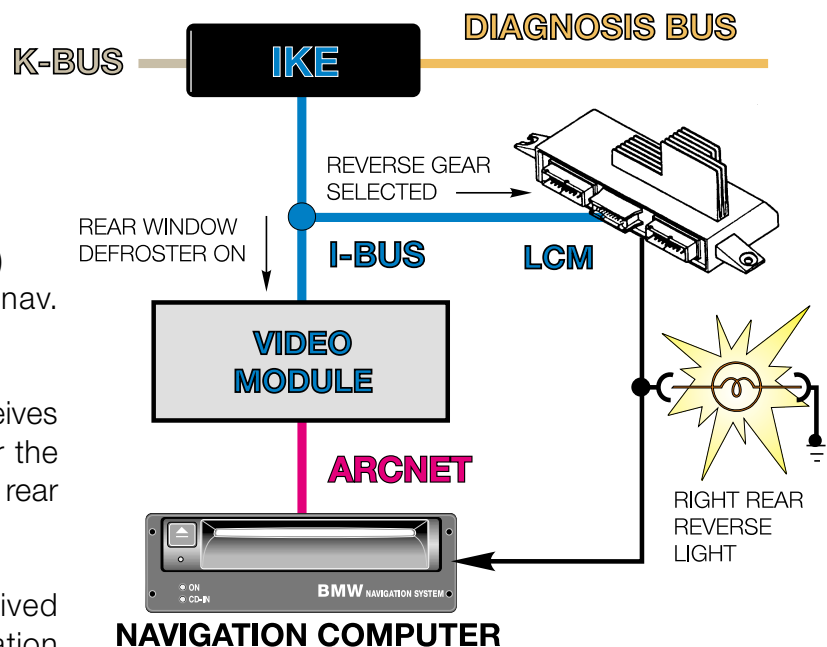

# MARK I NAVIGATION SYSTEM OPERATION

**NOTE:** There are several methods for entering destinations into the navigation system computer. The following example uses the rotary knob to input a destination from the input destination screen.

Enter the navigation system by pressing the GPS-Navigation button from the main menu.

After acknowledging the system warning, any previously entered destination is displayed. This destination must be deleted or overwritten in order to input a new destination.

The rotary knob is used to enter a city/town from an Alpha-Numeric menu or the destination can be selected from the index of listed locations that are mapped on the CD.

Next the desired street is entered in the same fashion. The street number can also be entered at this time. If the street number is on the database CD, the nav. system will guide the driver directly to the house number.

There are two choices for route preference available from this screen,

- “most use of highways”
- “least use of highways”

With either selection, the system will pick the most direct route to the destination, based on the selection.

Once the location has been entered, the navigation system is ready for guidance. Press the directions button.

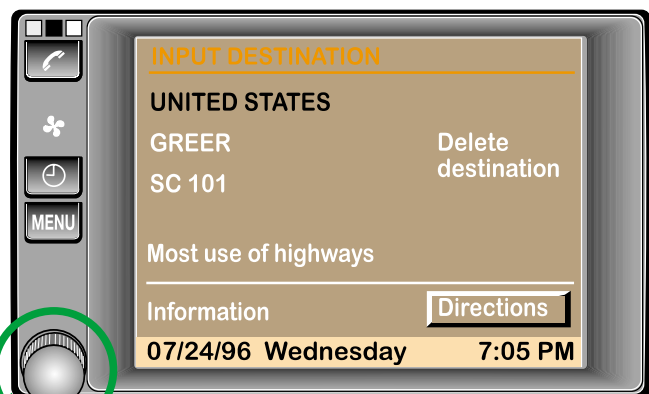
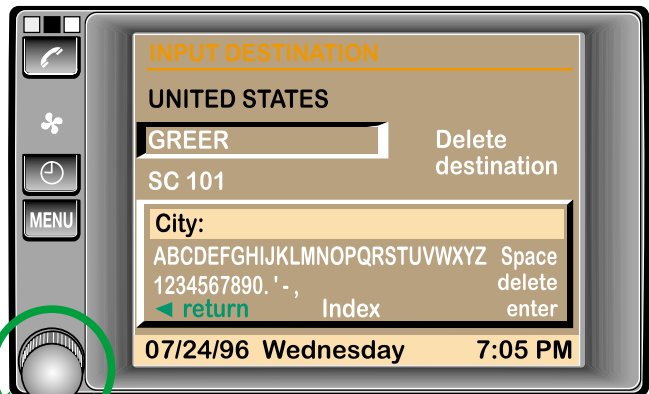
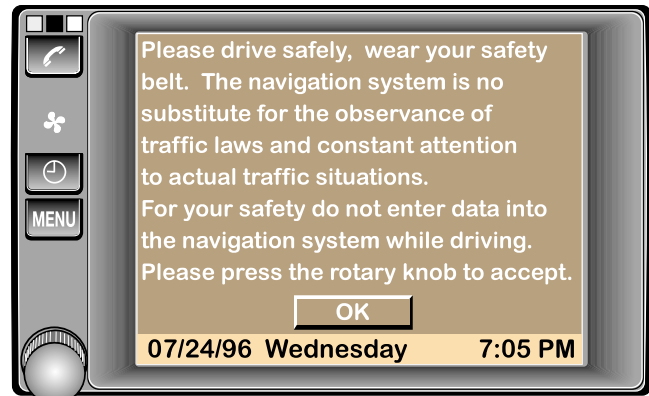

The system will guide the driver via:

- **The graphical direction display** - which consist of arrows and text that show the current location, the destination and direction of travel. When turns or intersections approach, a voice command will inform the driver when to turn.

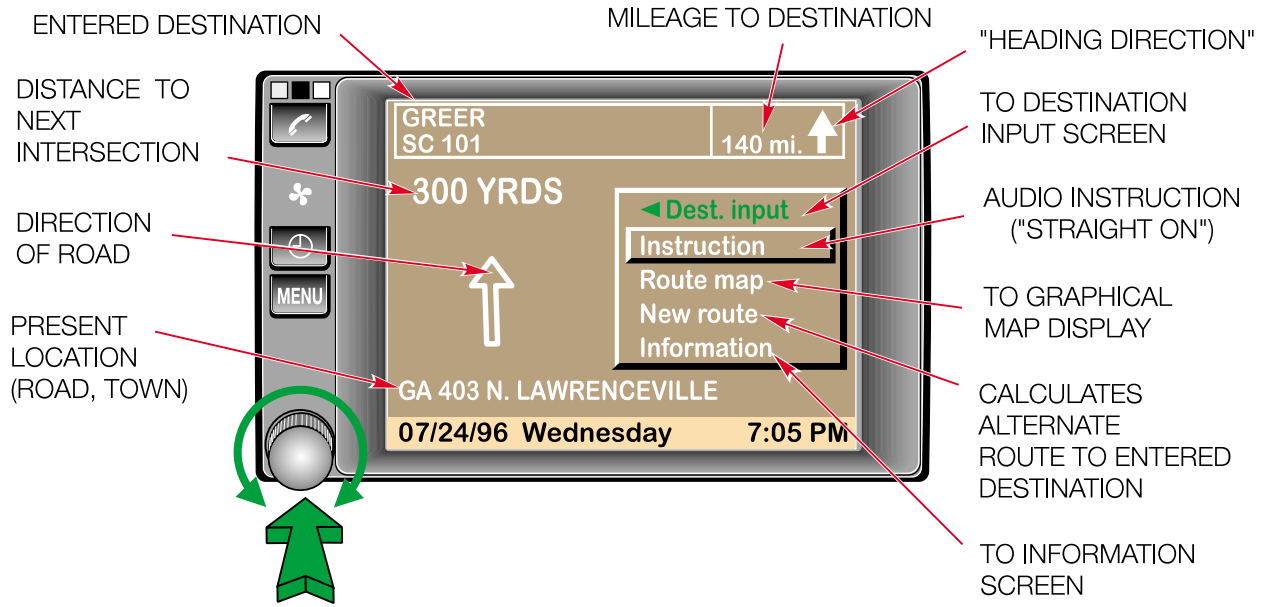

- **The graphical map display** - which consists of a digital road map showing the entered route, destination and vehicle position.

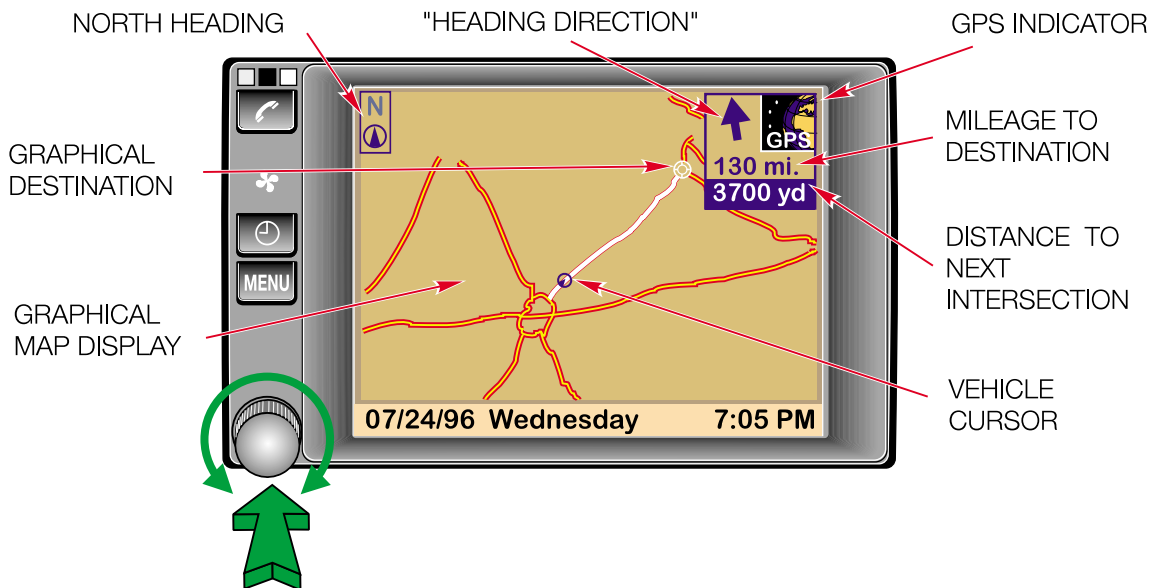

In either display mode a voice command will inform the driver when to turn when turns or intersections approach.

The navigation screen display can be turned OFF (from main menu) and the system will remain in operation. The voice command will continue to inform the driver when to turn.

## GRAPHICAL MAP SCALE

The graphical map display can be scaled up or down from 400 feet to 50 miles depending on the distance to the destination.

This function is activated by turning the knob one click, and a sub menu will display on screen. Choose "Scale" and adjust as needed.

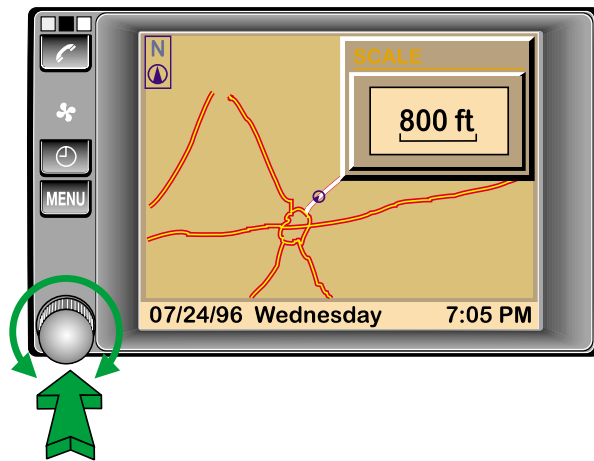
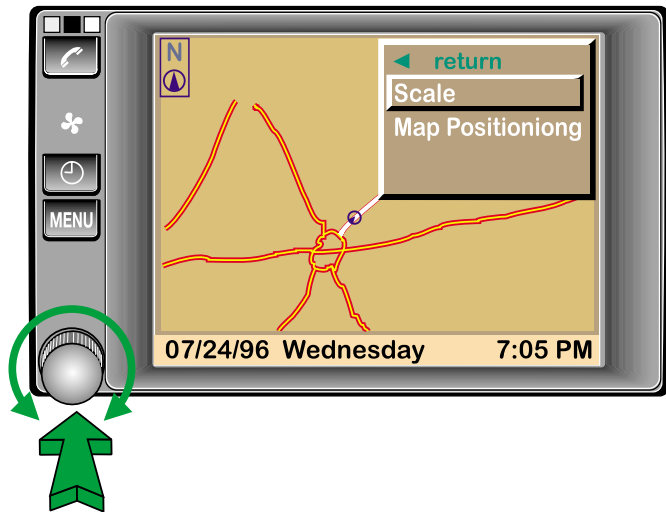

## GRAPHICAL MAP POSITIONING

The graphical map can be displayed "North Pointing" or "Direction of travel". This function is also accessed by turning the knob one "click" as described above.

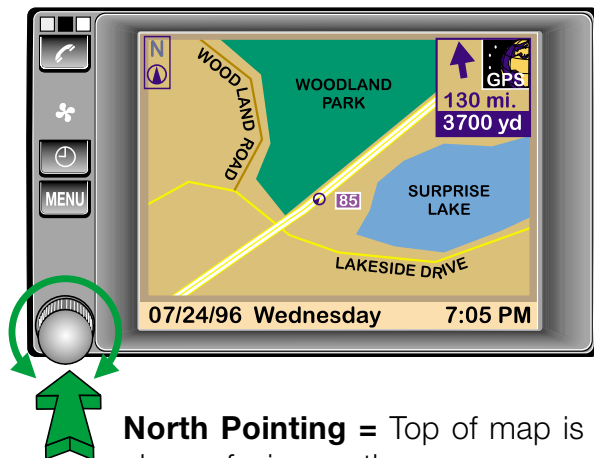

**North Pointing** = Top of map is always facing north.

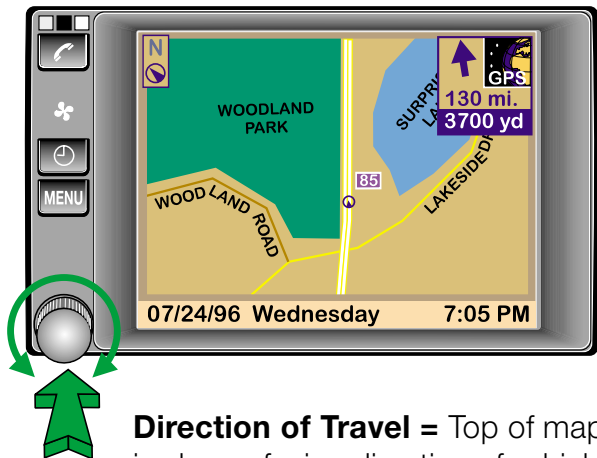

**Direction of Travel** = Top of map is always facing direction of vehicle



## GPS INDICATION

Satellite reception, by the navigation system, is indicated in the upper right corner of the display screen. The number of satellite signals being received by the system is indicated by small white dots in the display that surround the picture of the globe. In addition, the GPS logo is displayed at the bottom of the graphic.

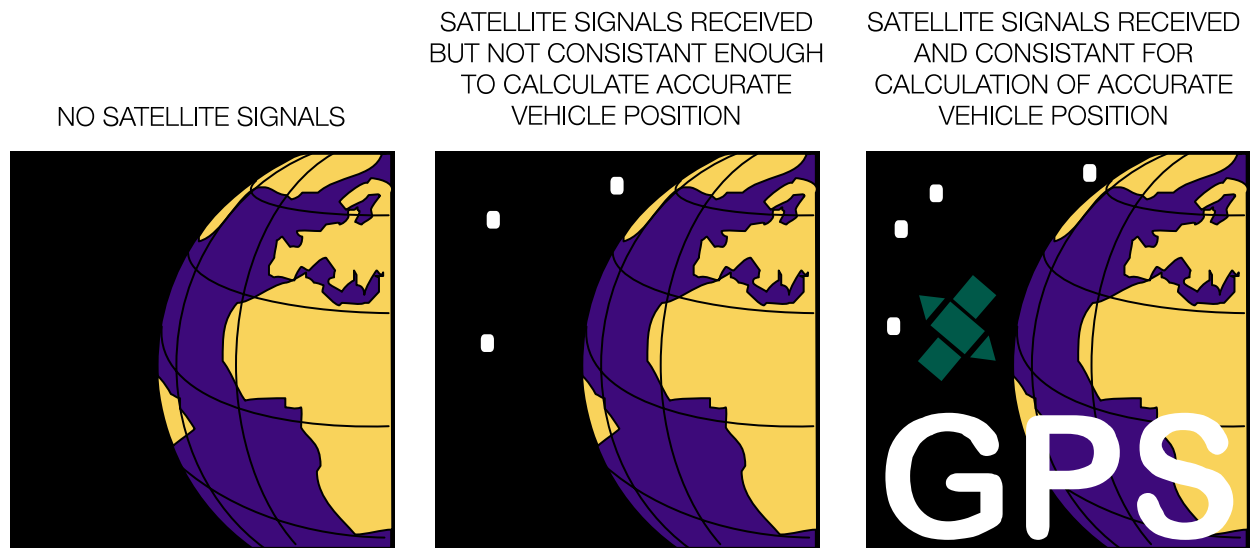

The number of dots indicate the number of satellite signals that the navigation computer is receiving.

If only the globe graphic is displayed, without the dots or logo, the vehicle is in a poor reception area or the signals are being blocked by some obstruction. The dead reckoning function of the compass and wheel sensors provide adequate navigation in this situation.

If the dots and logo fail to display in a known good reception area, than a fault is indicated and troubleshooting should be carried out according to the fault symptom ‘GPS Problems’.

---

---

---

---

---

---

---

---

---

---

## NAVIGATION SYSTEM INFORMATION SCREEN

The Information screen provides access to the balance of the navigation system features including:

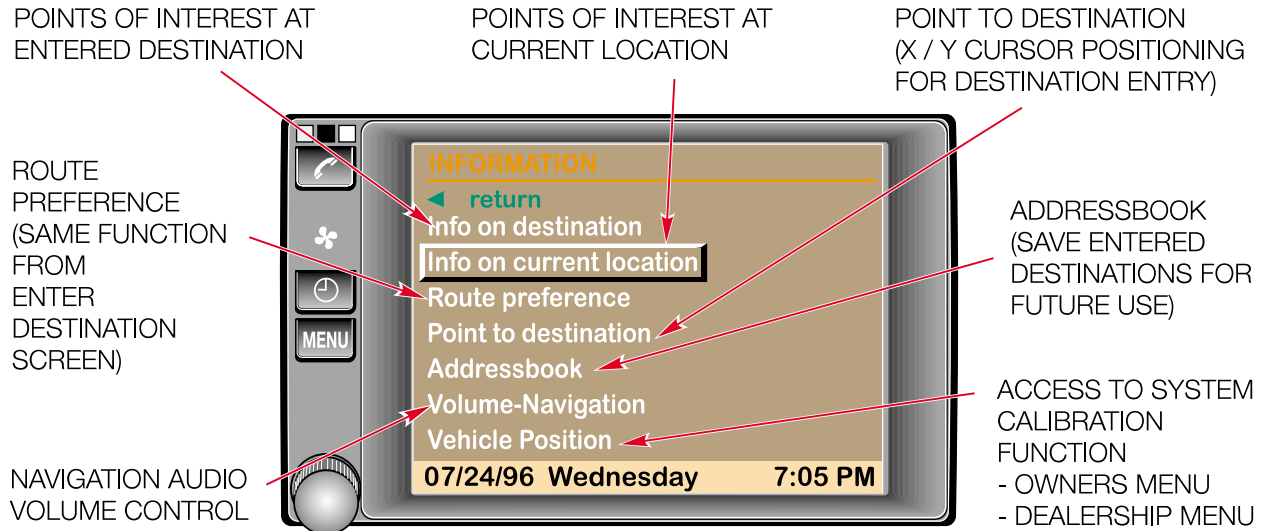

Information on destination or current location provides a detailed list of stored points of interest such as:

- Gas stations
- Banks
- Restaurants
- Hotels, etc.,

This feature allows the user to enter the point of interest and change the route to guide the driver to the entered point.

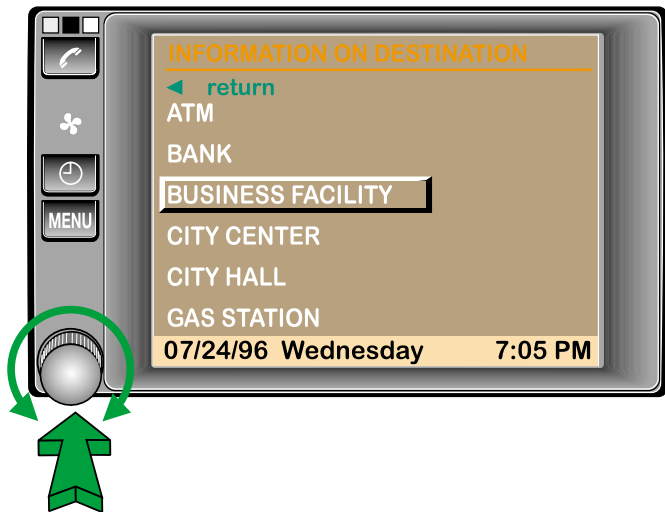

## VEHICLE POSITION

The vehicle position selection from this screen provides access to the Calibration function of the navigation system.

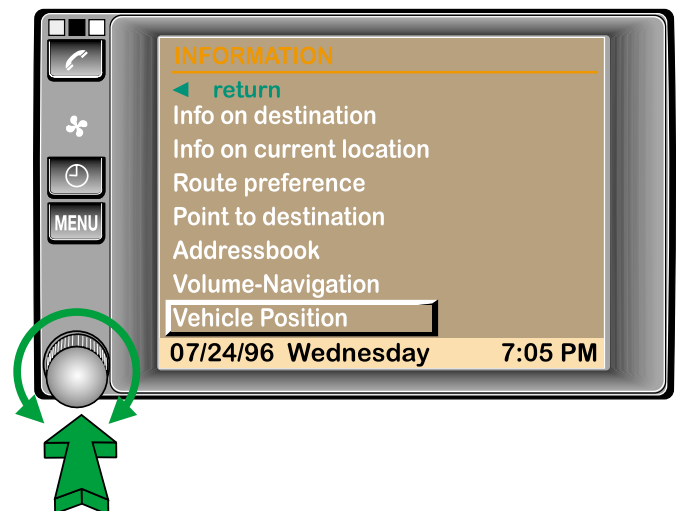

# MARK I NAVIGATION SYSTEM CALIBRATION

The Mark I navigation system will require “calibration” at some point in its service life. The reasons that cause the necessity of a calibration procedure are as varied as inaccurate navigation display data, after the installation of a new set of tires, to the replacement of a shattered rear window.

Calibration procedures are divided into two categories

- **Vehicle Owner Calibration** - Calibration that the vehicle owner can perform.
- **Dealership Calibration** - Procedures only an authorized dealer can perform.

This section is divided into these two categories. Always consider what the owner of the vehicle could have inadvertently changed when troubleshooting and/or calibrating the vehicle. Check these data inputs **before** you embark on a full dealership calibration procedure.

## VEHICLE OWNER CALIBRATION

The vehicle owner’s manual contains the information on how to set the vehicle position and adjust the tire calibration. Both of these adjustments are found on the vehicle position screen which is accessed from the information screen as shown on page 24.

***“The Owner Calibration Procedures shown on pages 25-27 are for information purposes only. A full Dealership Calibration is the recommended method for accurate system calibration.”***

### 1. RESETTING VEHICLE POSITION

A mis-located vehicle is caused by driving in and out of the digitized map areas or starting a vehicle after it has traveled on a flat bed or train. The system will eventually relocate itself automatically through GPS but it can be entered through the on-board monitor for immediate resetting.

From the Vehicle Position Screen, rotate the knob to “city:” and push the knob. Enter the city and street information as you would enter a destination. Press the “Intersection” button and select the closest intersecting street from the displayed index.

Drive to the entered intersection and press the “Crossing the intersect.” button when you cross.

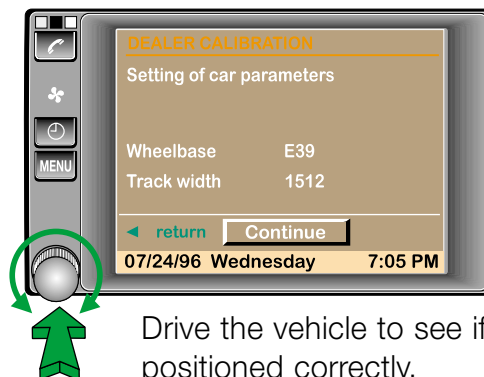

Drive the vehicle to see if it is positioned correctly.

## 2. ADJUSTING TIRE SIZE

Tire calibration is a required input for the Nav computer to base, **tire rotation: distance covered ratio**. It should be checked to determine that the entered tire size is the same as the tires equipped on the vehicle.

Additionally, if the vehicle does not have factory equipped tires installed, the tire calibration will need to be changed to match the new tire size.

Press the “Tire Calibration” button from the vehicle position screen. The following message is displayed noting the overwrite of existing values once the procedure is completed.

Press continue to access the tire adjustment screen.

Press the tire size and rotate the knob to see if the tire size is listed.

Select the correct tire size and press the button once again. Note that the tire circumference size automatically changes to the set tire size.

If the tire size is not listed the tire circumference value must be entered manually by rotating the tire size button to the “???” position.

Press and adjust the actual tire size dimension in millimeters.

This value is available from the tire manufacture or it can be measured as illustrated on the next page.

Once the correct tire size or circumference has been entered, press the return button to return to the information screen or press the continue button to go on to the Precision Adjustment screen.

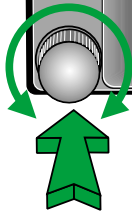
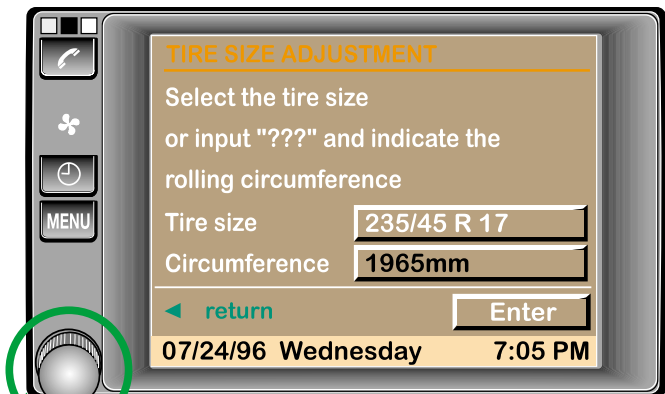
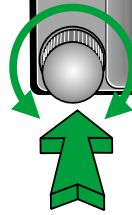
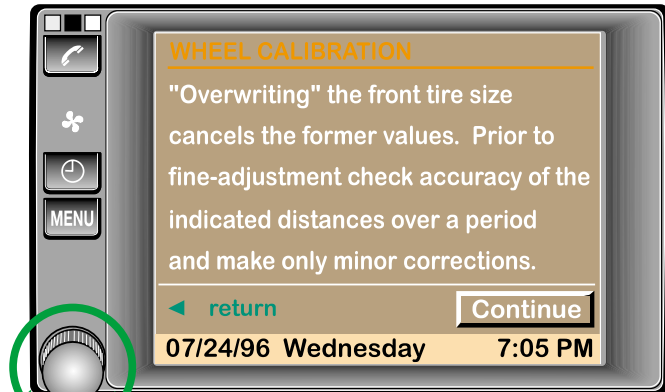

## TIRE CIRCUMFERENCE MEASUREMENT

1. PLACE A STRAIGHT EDGE UP AGAINST THE TIRE DIRECTLY IN THE VERTICAL CENTERLINE OF THE TIRE

4. PLACE STRAIGHT EDGE AGAINST TIRE. MOVE VEHICLE PRECISELY TO ALIGN THE MARK WITH THE STRAIGHT EDGE.

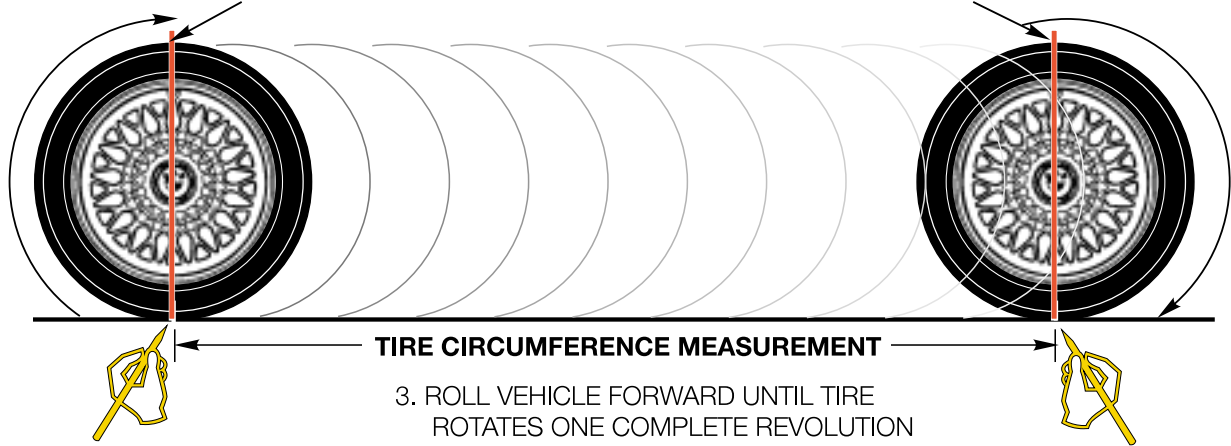

2. MARK TIRE AND GROUND AT SAME POINT

3. ROLL VEHICLE FORWARD UNTIL TIRE ROTATES ONE COMPLETE REVOLUTION

5. MARK GROUND. MEASURE DISTANCE.

## PRECISION ADJUSTMENT

This screen activates a “Regulator” function that “fine tunes” the tire adjustment with regard to the displayed distance to an intersection measurement.

If the displayed measurement is consistently “0” before the intersection is reached slide the regulator bar towards the “-” end of the scale.

If the displayed measurement is consistently “0” after the vehicle has passed the intersection, slide the regulator bar towards the “+” end of the scale. When finished press the Ready button.

It will require a little “trial and error” to achieve precision adjustment.

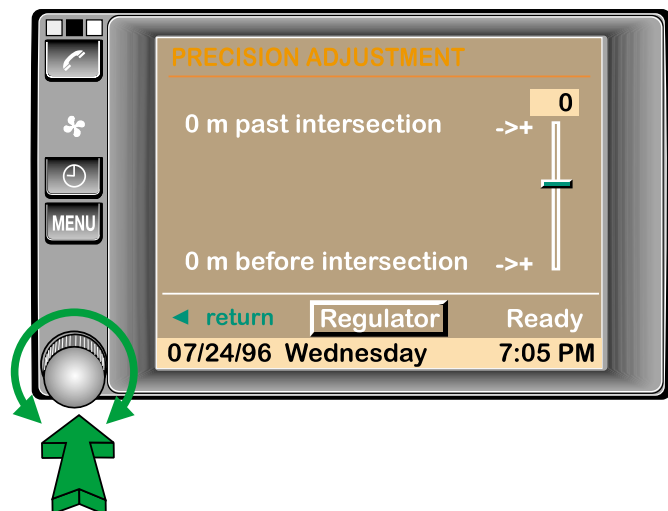

Keep in mind that distance displays that are 30’ to 60’ out of intersection, in either direction, are within the design tolerances of the system and are acceptable. Don’t expect major results from using the regulator function.

If there is an unacceptable displayed distance (more than 150’), the most effective method to calibrate the system is to keep the regulator adjustment at “0” and perform a full dealership calibration procedure.

---

## DEALERSHIP CALIBRATION

Calibration of the navigation system must be checked or performed when various components of the system are changed or when the troubleshooting procedures of the diagnostic module call for it.

The calibration procedures are stored in the Navigation computer module and are called up for display on the LCD screen.

Complete or partial calibration is required when the following components are changed:

- Navigation Computer Module - Complete calibration automatically required.
- Magnetic Field Sensor or rear window (defroster replacement) - Sensor Check and Compass Calibration
- Tires/Wheels - Setting of tire size in tire calibration screen (from Owner Calibration Section) and wheel sensor calibration.

Additionally, if the vehicle has had body work (new sheet metal or welding work) a sensor check and Compass calibration should be performed .

### **The following preconditions must exist before a successful calibration can be carried out:**

- No faults stored in the Navigation system.
- The correct tire size set in the tire calibration screen. Tires inflated to correct pressures.
- Known location of:
  - A large flat parking lot with enough width to allow the vehicle to be driven in tight circles to the left and right.
  - A “back street” (no traffic) with a minimum 100 meter (approx 330 ft) straight path.
- There should be no overhead power lines/transformers in the immediate vicinity of the parking lot to create any magnetic interference with the magnetic field sensor.
- All electrical consumers should be switched off - Rear window heating, Radio, seat heating, air conditioning, etc.

### **TOOLS NEEDED FOR DEALERSHIP CALIBRATION**

- Metric tape measure (minimum 8 meters).
- Piece of white chalk.
- 2” X 2” angle iron (6’ long).

## CALIBRATION PROCEDURES

The navigation system calibration screen menu is called up from the information menu screen.

Select "Vehicle Position" from the information screen, then **press and hold the menu button** for a few seconds. The system will enter the calibration mode.

Press "Continue" to proceed with the desired system calibration.

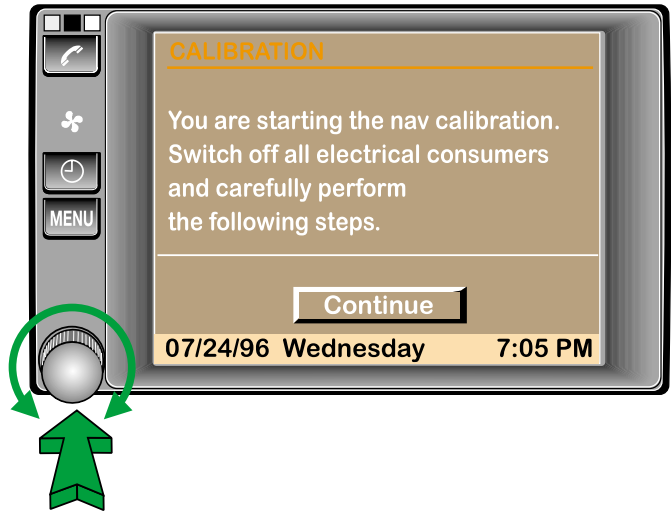

The first Dealer calibration screen provides five selections. A full dealer calibration procedure consists of carrying out all five selections.

Though they can be done individually with positive results, it is recommended to complete all five steps to achieve consistent positive results.

Start at "Setting Car Parameters" and end with "Finish Calibration".

**NOTE:** If a new navigation computer is being calibrated for the first time, the individual buttons will not be selectable.

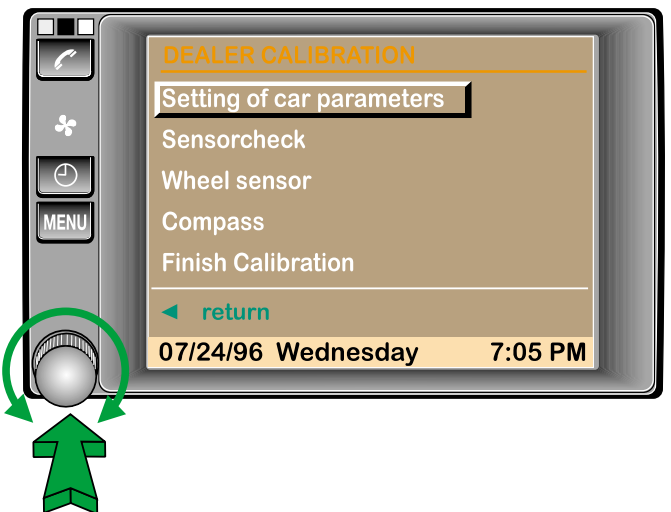

The system will automatically go into a "fixed sequence calibration" requiring all steps be performed.

---

---

---

---

---

---

---

---

---

---

## 1. SETTING OF CAR PARAMETERS

There are two settings in the parameters screen:

- The vehicles wheel base which will be an E38 long/short wheel base or an E39.
- The vehicle's track which is as follows for the different vehicles:

E38 - long = 1549

E38 - short = 1549

E39 = 1512

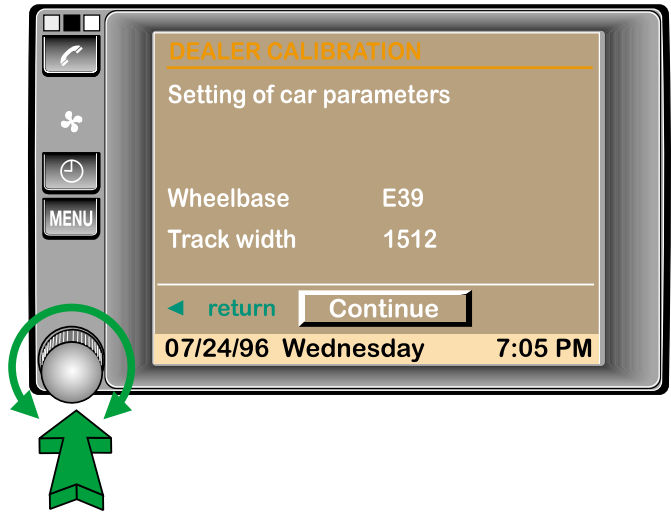

Changing these settings is not required unless a new Navigation computer is installed in the vehicle. If a new nav computer is being calibrated for the first time, enter the vehicle type.

**NOTE:** These settings should be checked as part of the troubleshooting procedures to verify that they are correct. If the displayed setting does not match the figures above, momentarily select another vehicle type and switch back to the correct vehicle. The track width value will change to the displayed values as shown above.

### AFTERMARKET WHEELS OR SUSPENSION MODIFICATIONS:

If the vehicle is equipped with aftermarket wheels or has modified suspension components, the track width **may** need to be manually adjusted. Do the following to obtain this figure:

1. With the vehicle on the ground (suspension loaded), measure the distance between the two front rims (inner rim tire bead lips) in millimeters and note the measurement.
2. Measure the thickness of one front rim (inside lip to outside lip) using calipers and note the measurement.
3. Add these two figures together. The total is the measured track width.

Turn the rotary knob to the vehicle type. Then turn the knob **“one click”** to the **LEFT** to access the track measurement. Turn the knob to enter the value manually. Press knob when finished.



## 2. SENSOR TEST

The Sensor Test performs a functional check of the wheel speed sensors and magnetic field sensor inputs to the navigation computer.

This test must be carried out if the navigation computer is replaced. The DIS will also call for this test to be carried out as part of the troubleshooting procedures.

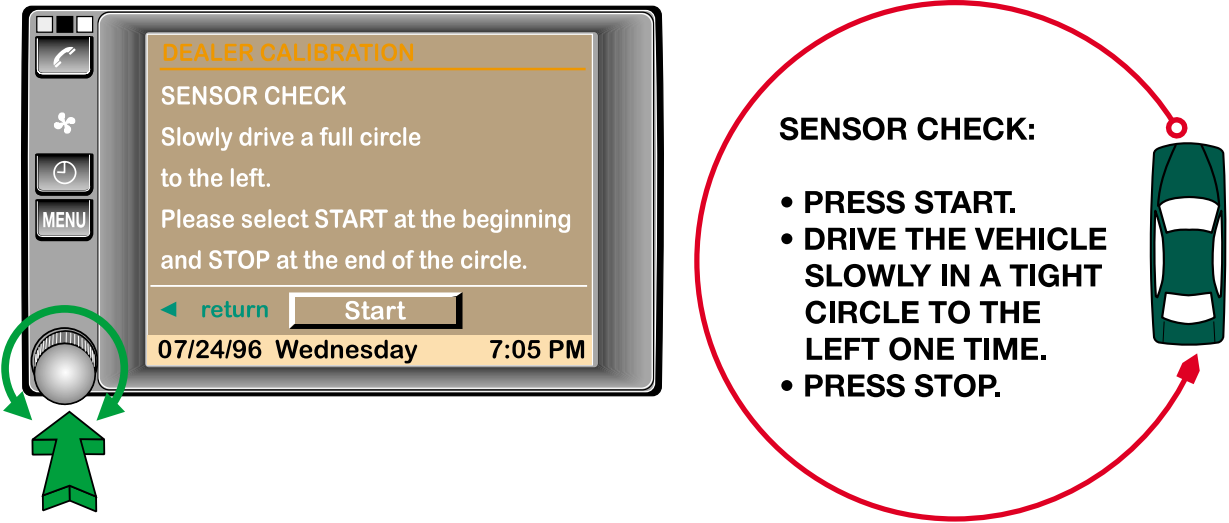

The test requires driving the vehicle in a tight circle at a speed of 6 MPH or less.

If there are no faults with the inputs, the system will display “Calibration Successful”. At this point the calibration procedures can be continued or the vehicle can be returned to the workshop to continue the diagnostic procedures.

---

---

---

---

---

---

---

---

---

---

---

### 3. WHEEL SENSOR

This procedure is necessary when the navigation computer or wheel/tires have been changed. The procedure calibrates the wheel circumference/speed sensor input to the navigation computer so that the distance traveled input is correct.

The tire inflation pressure must be checked and correctly set prior to carrying out this test.

**NOTE: The screen instructions will indicate a 4 and 6 meter distance in this procedure. Field testing has proven that a distance of 8 meters provides a more precise wheel sensor calibration.**

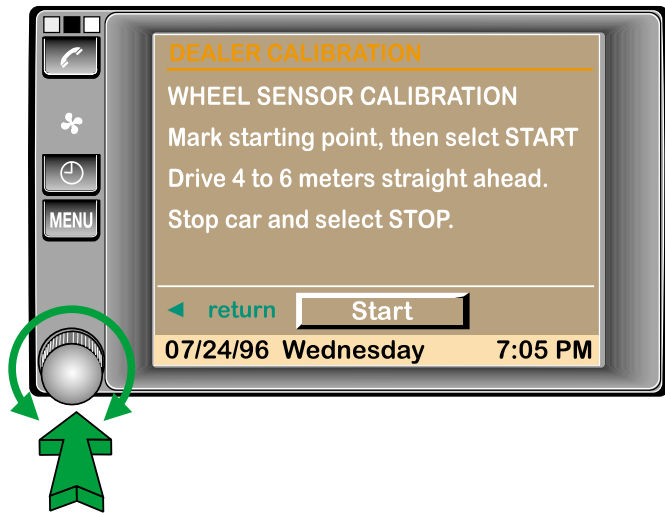

1. Make sure the front wheels are facing forward. Place the angle iron against the back side of the rear tires.

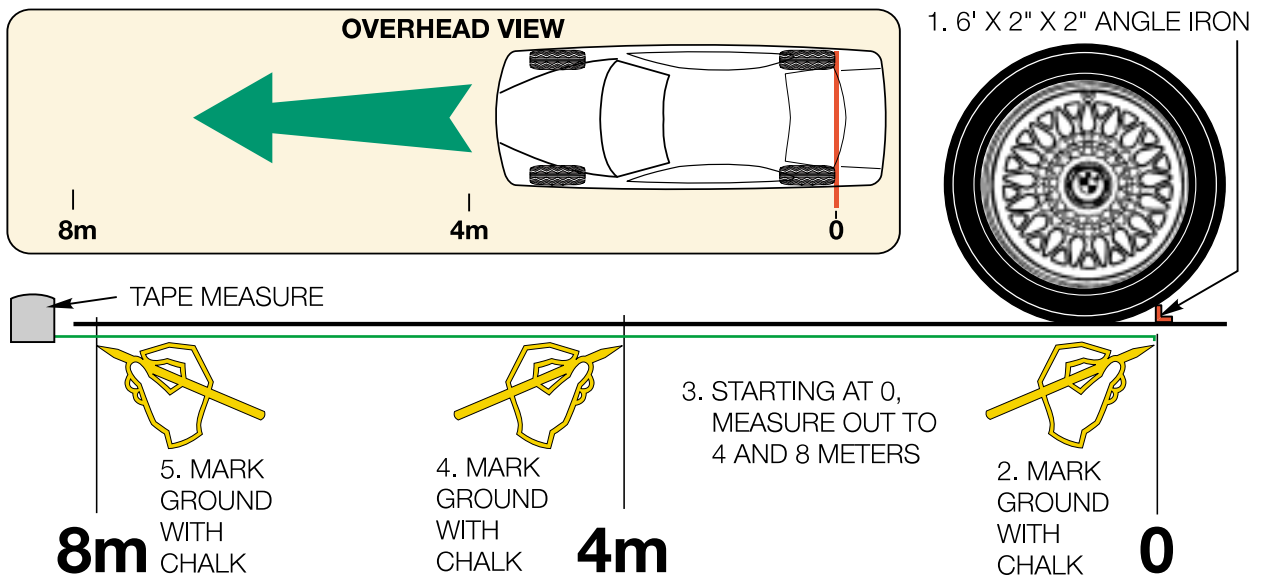

2. Mark the road with the chalk where the angle iron contacts the road. This is your starting point.
3. Using a metric tape measure, measure out 4 and 8 meters from the starting point
4. Mark the distance on the road surface at four (4) meters.
5. Mark the distance on the road surface at eight (8) meters.

6. Press the start function on the On-board monitor.
7. Drive the vehicle slow and continuously forward (don't stop) until the rear tires are between the 4 and 8 meter marks (go as close to the 8 meter mark as possible) and

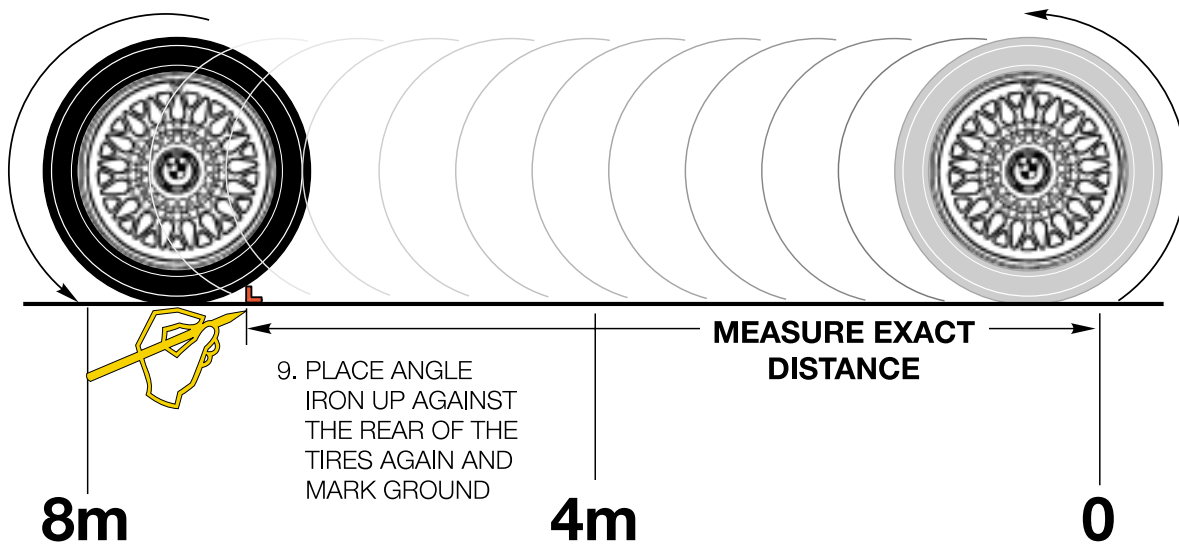

- stop.
8. Press the stop button on the monitor. Set the parking brake.
9. Place the angle iron up against the rear of the back tires again and mark the ground with the chalk.
- 10 Precisely measure the distance from the starting point to the end point (tolerance < 1cm) and input this value using the rotary knob. Then press continue.

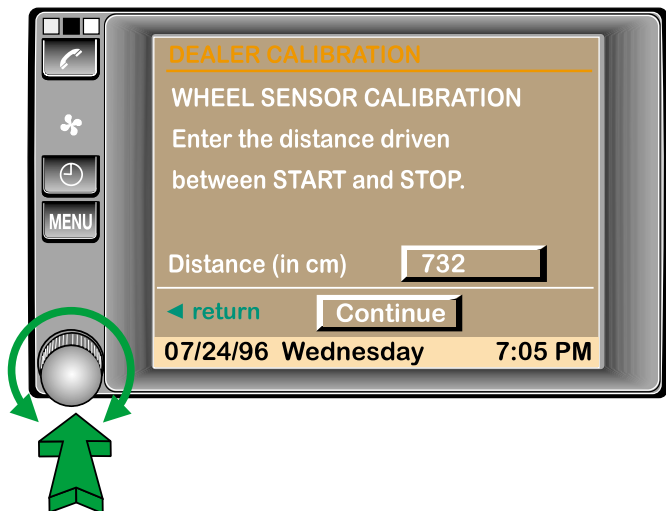

Drive the vehicle to the known minimum 100 meter street or area.

Press the start button by driving the vehicle **straight ahead** for a distance of at least 100 meters.

- The vehicle speed must also be < 40 KMH and the steering wheel must be held straight.
- Once you have travelled at least 100 meters stop the vehicle and press stop.
- The monitor screen will display the calibration has successfully completed.

### 3. COMPASS (MAGNETIC FIELD SENSOR CALIBRATION)

The magnetic field sensor must be calibrated if:

- The field sensor is replaced
- The navigation computer is replaced
- The rear window with the heating grid is replaced
- Body work (welding, reconstruction)

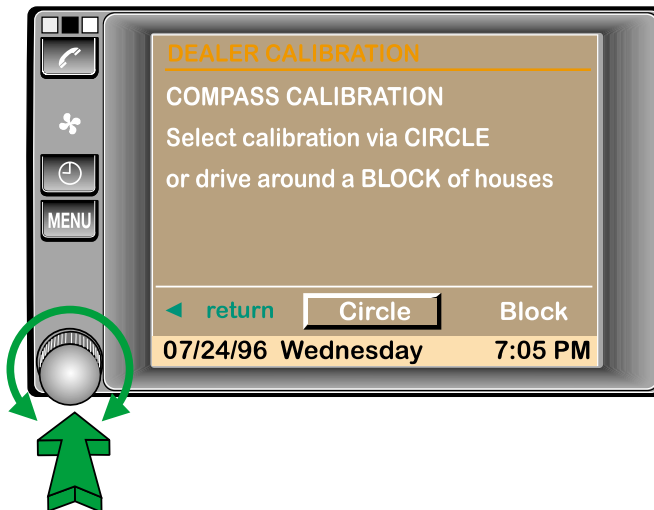

Calibration of the field sensor is a **three step process** that includes:

**COMPASS STEP 1.** Allowing the sensor to read all directions of travel. This is carried out in one of two different methods;

- Driving the vehicle in several tight “circles”, or
- Driving several times around a “block” (“city block”, “block of houses”)

One of these methods must be selected on the monitor before beginning.

---

---

---

---

---

---

---

---

---

---

---

---

---

---

---

---

---

---

---

---

---

---

---

---

### Preferred Method- CIRCLE

**Driving the vehicle two complete circles** - both counterclockwise and clockwise - will cover all directions.

Press Start, the speed of the vehicle must not exceed 6 MPH during the calibration.

Press Stop when you have completed. The monitor will indicate that the navigation computer has seen all directions of travel by displaying "Calibration Successful".

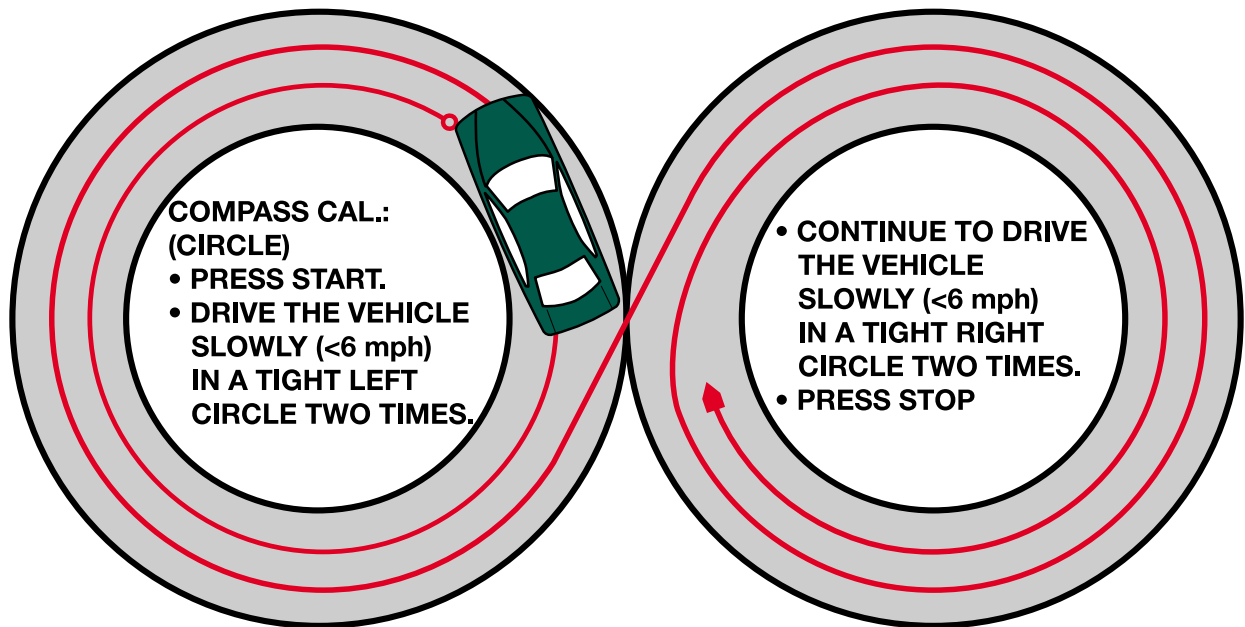
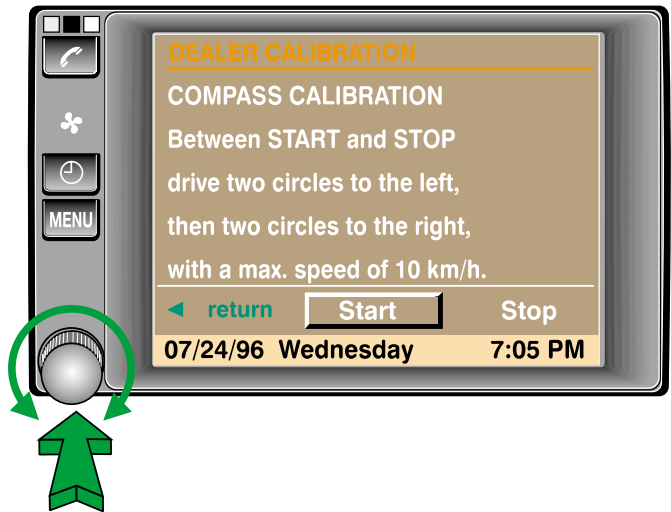

### Alternate Method - BLOCK

**Driving the vehicle around a block** several times will also allow the navigation computer to see all directions of travel.

The monitor will automatically indicate when this section of the calibration is completed.

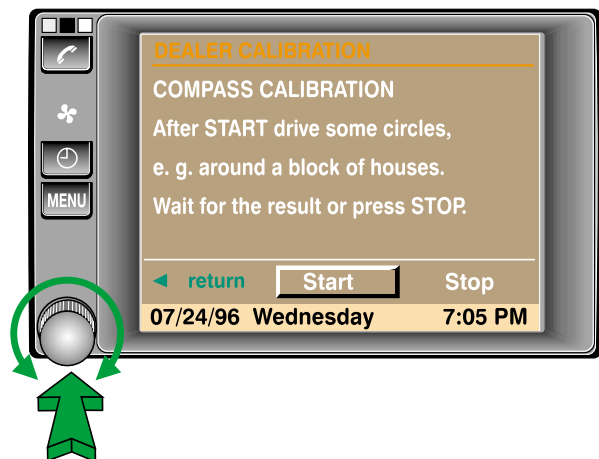

**COMPASS STEP 2.** Calibration of the magnetic field sensor input to the navigation computer.

This procedure is only possible after STEP 1 has been completed. Step 2 is carried out in one of three different methods;

- Calibration using a digitized address.
- Calibration using the GPS satellite signals.
- Angular calibration using the direction of a long section of road.

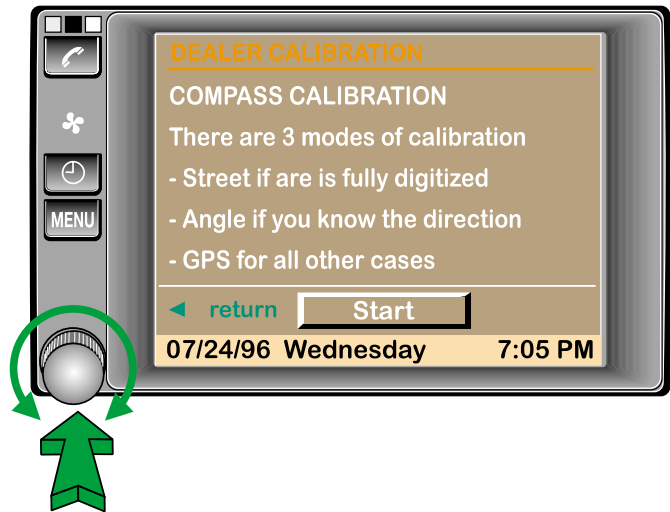

**Preferred Method - DIGITIZED ADDRESS**

**This procedure can only be used within a fully digitized CD map area.**

The actual location is entered into the on-board monitor and the navigation system will display a route between two road intersections, along which the vehicle must be driven.

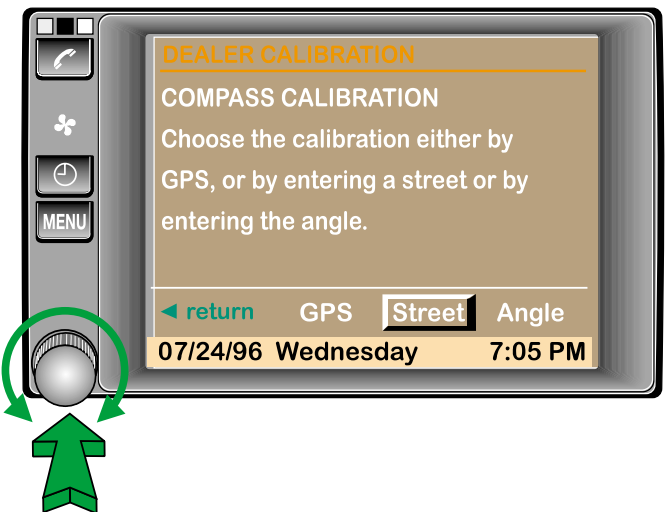

1. If the town is not already displayed, enter it in the same method as entering a destination.
2. Enter the street at which you want to start the calibration.
3. Press the intersection button.

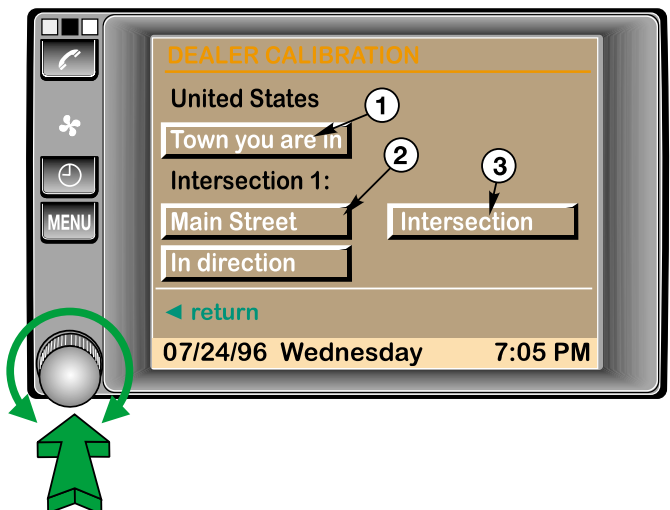

4. Select the street from the list of intersecting streets that is close to where the vehicle is at this point.
5. Press the “In direction” button. This brings up a list of streets that are in the direction of your planned calibration drive.
6. Select the street that is in your planned direction of travel.
7. Press Start when you begin to drive.

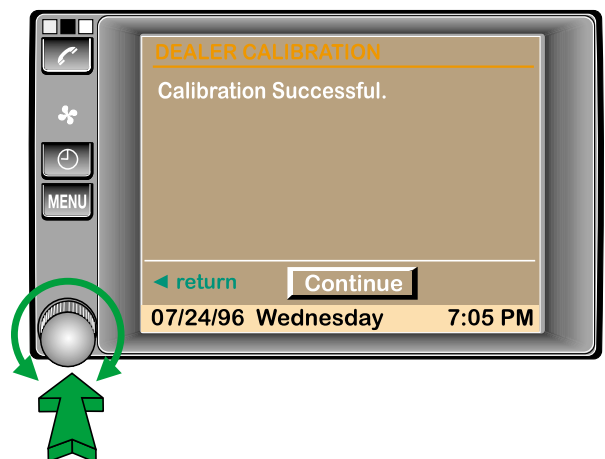
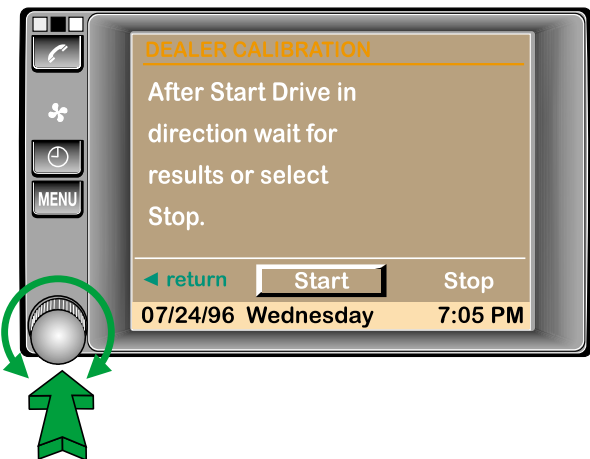
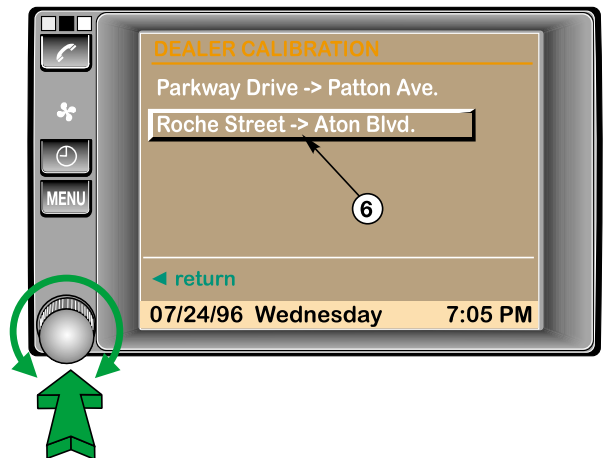
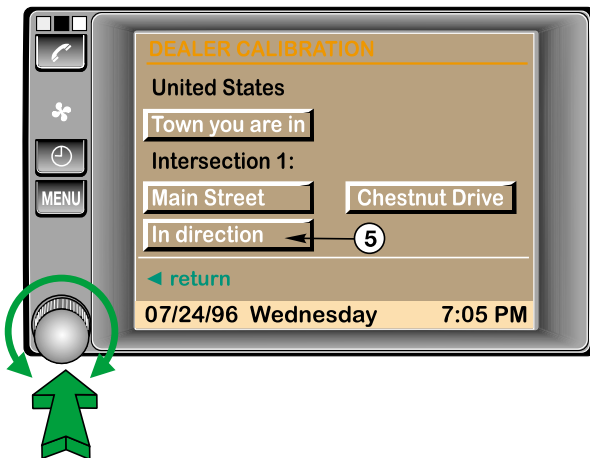
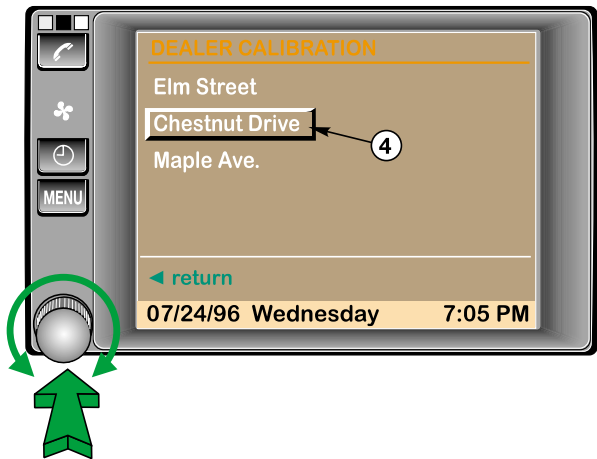

The screen will automatically confirm that the calibration was successful. Press the continue button to go to Compass Step 3; Rear Window Defroster grid compensation calibration

## COMPASS STEP 2 (Continued)

### Alternate Method - GPS

This requires driving the vehicle in all directions until the navigation computer fixes the field sensor inputs.

This may require several minutes of driving to complete this step. The roads should be as straight as possible and free from any overhead obstructions that might block the upward view to the satellite signals.

The screen will automatically confirm that the calibration was successful.

Press the continue button to go to Compass Step 3; Rear Window Defroster grid compensation calibration

---

---

---

---

---

---

---

---

### Last Method - Angle

Angular calibration using the direction of a long section of road. To use this method, the geographical angle of the road must be known and input into the navigation computer to within  $\pm 1^\circ$ , then the vehicle must be driven along this route.

Any of these three described methods will perform the second step in the compass calibration. Once this step is complete, the last step can be carried out.

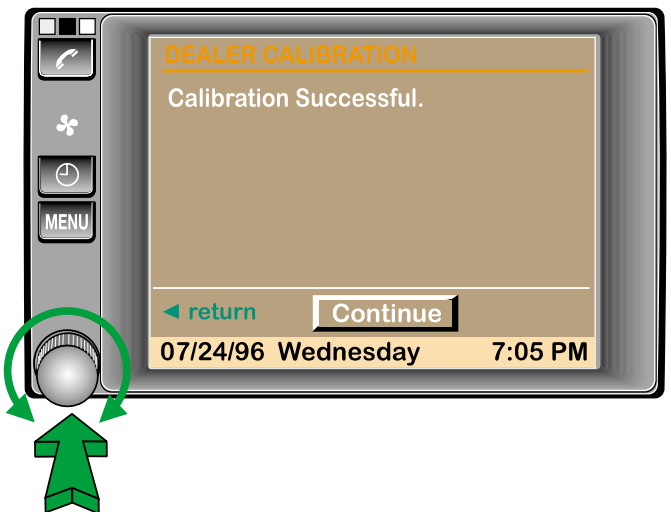
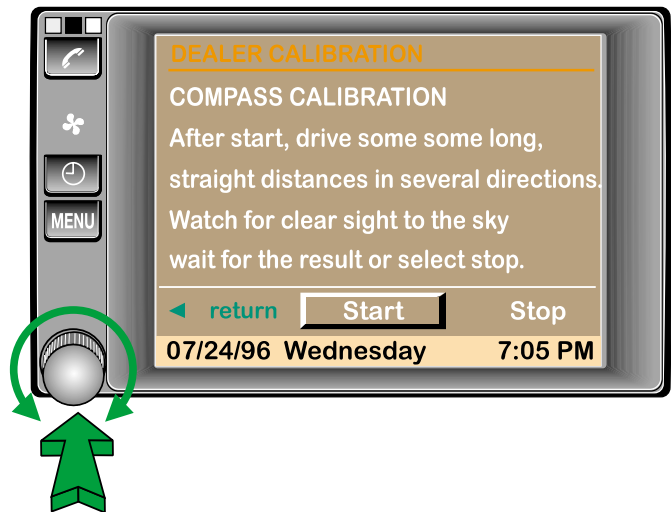
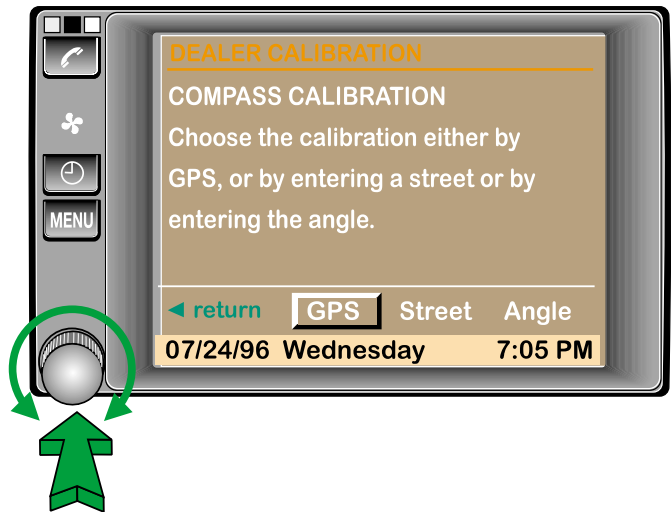



### COMPASS STEP 3 - REAR WINDOW DEFROSTER COMPENSATION

This procedure is only possible after steps #1 and #2 have been successfully completed.

The navigation computer determines the magnetic field generated by the defogger grid so it can compensate for this when the rear defogger is switched on.

- Switch the rear defogger ON and confirm the input on the Monitor screen. Wait for acknowledgment by the navigation system.
- Switch the rear defogger OFF and confirm the input on the monitor screen. Wait for acknowledgment by the navigation system

### FINISH CALIBRATION

Once all of the required calibration procedures have been carried out, press the finish calibration button.

This will display whether the calibration process was successful or if faults or problems have occurred that require troubleshooting with the DIS .

---



---



---



---



---



---



---

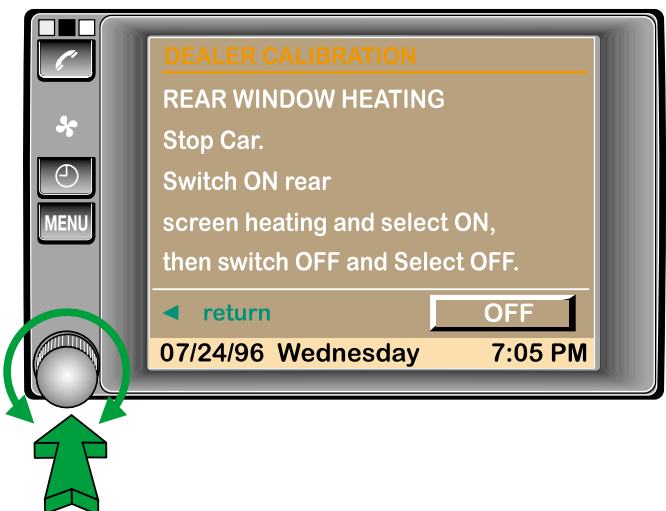
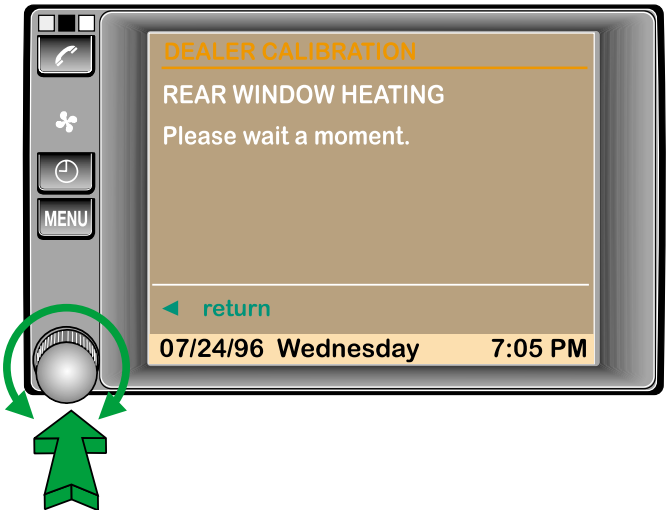
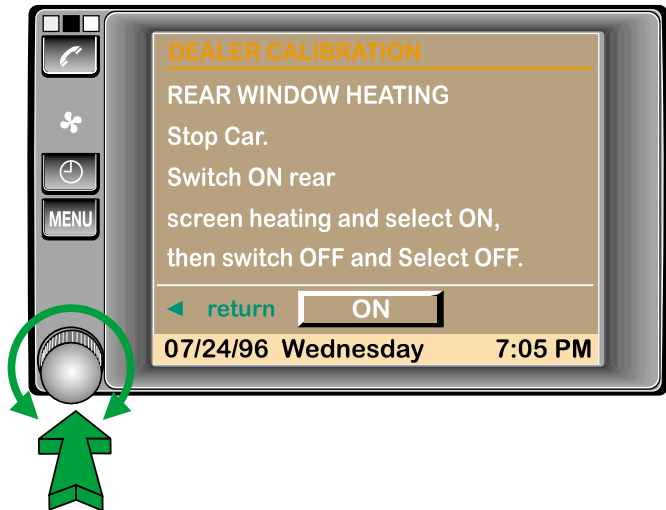

# MARK I NAVIGATION SYSTEM SOFTWARE LOADING

As new operational software becomes available, it will be necessary to update existing navigation computers with this latest version software.

As with other BMW systems, the software will be distributed on a CD. It will be introduced by an SI or IDC bulletin describing the revisions of the new CD and the loading procedures as outlined below.

The software loading procedure is also required if the troubleshooting procedures of the DIS tester call for it..



The procedure for loading the updated software is as follows:

- Remove the existing digitized map database CD.
- Turn the ignition switch On.
- Insert the new software CD.
- Any currently running program will be interrupted and the message “Please Wait” will be displayed on the monitor screen.
- The new software will automatically be installed. When the procedure is complete, the screen will display “Software Loaded Successfully”.
- The software loading must be acknowledged by pressing the rotary knob and removing the software CD.
- The digitized map CD is then reinstalled - followed by a map guided test drive to ensure proper operation of the navigation system.



---

# MARK I DIAGNOSIS AND TROUBLESHOOTING

There are three diagnostic programs for the On Board Monitor system with the Mk-1 Navigation Computer with video module.

Based on the customer complaint, one or more of these systems will need to be accessed with the DIS Tester for diagnostic purposes.

## CONTROL MODULE ID: BOARD MONITOR

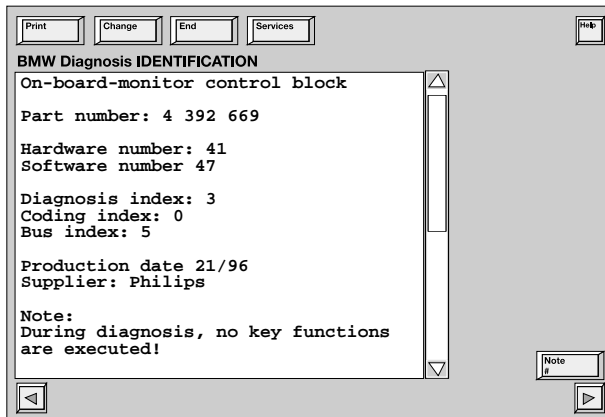

## CONTROL MODULE ID: VIDEO MODULE

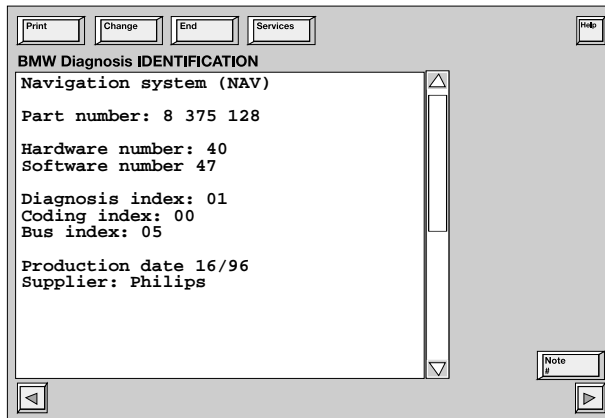
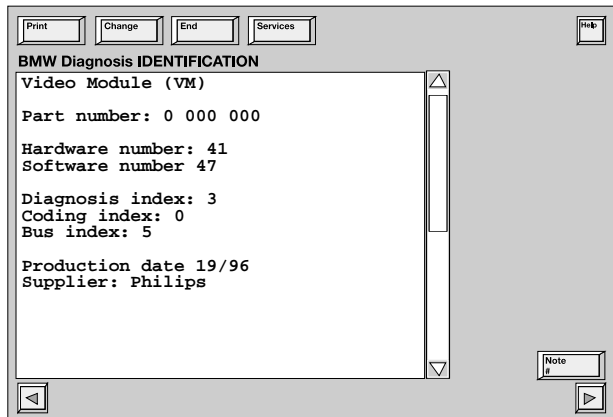

## CONTROL MODULE ID: NAV COMPUTER

The On Board Monitor system must be fully functional before any visual displays, inputs or programming can be carried out.

The Video Module must be fully functional before any graphical displays can be transmitted to the Monitor unit.

The Navigation Computer must be fully functional before any programmed destinations can be called up for display and directions.

In all cases fault troubleshooting should begin with the "Fault Symptom" troubleshooting paths provided by the DIS.

In the case of positioning errors or faults with the Navigation System, the DIS will request a "Sensor Test" be performed prior to carrying out the diagnosis. This test procedure is outlined in the calibration procedures.

The navigation system diagnostic software has a “SELECTION” screen that is unique to any previous system.

- The choice, **1 - “Start diagnosis again”**, means to start the diagnostic session (either the first time or restart a fresh diagnostic session.)
- **2- “Sensor test has already been carried out, reassume diagnosis.”**, means to resume the diagnostic session. This selection is used when you have first started a session and the instructions on the DIS screen request that you disconnect the vehicle and bring it outside for a sensor check or another “field test” of some type as described in the diagnostic pages. When you return to the DIS, Select #2 to resume the diagnostic session started previously.

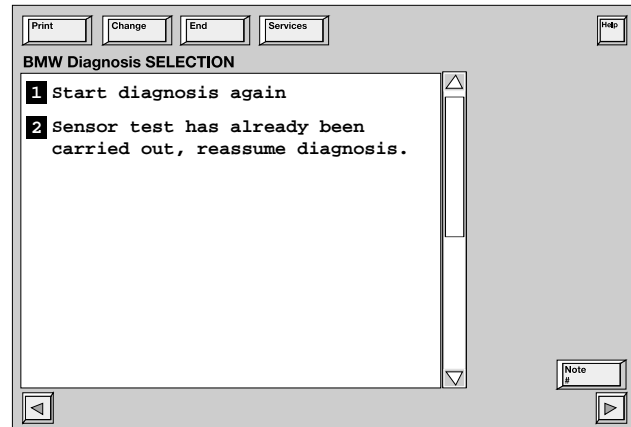

The Navigation Service Functions contains calibration data screens to review the vehicles present state of calibration (calibration status list). The calibration data (#2) is set up for E38 vehicles only at the time of navigation system introduction.

Calibration data of wheel-sensor calibration provides a printout page of the vehicles actual distance to wheel sensor pulse. This screen will prove helpful when dealing with the technical hotline if additional data is requested from them on wheel sensor calibration data values.

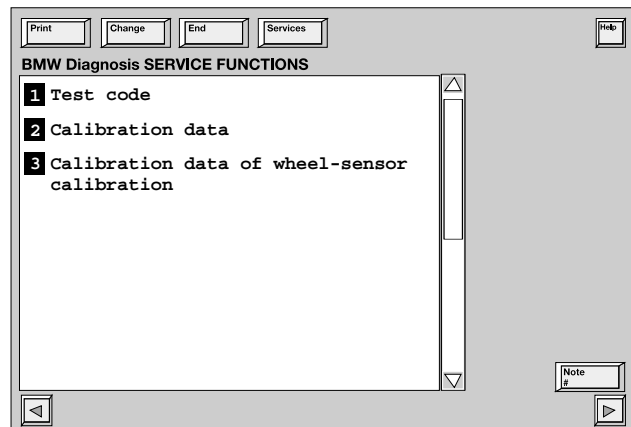

## NAVIGATION COMPUTER FLASH CODES

The “ON LED” of the navigation computer automatically provides flash codes for when a fault is present.

- **Single Flash** = Internal control module fault.
- **Triple Flash** = ARCNET data link problem (open, short).

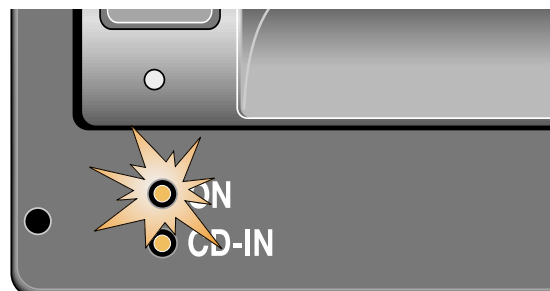

---

## **MK-2 NAVIGATION SYSTEM**

**Model: E38, E39, E53, E46**

**Production Date: From 9/97 to 9/00.**

### **Objectives**

After completing this module you should be able to:

- Explain the differences between Mk-2 and Mk-2 Navigation.
- List the components used in the system.
- Describe the operation of the Gyro Sensor.

## MARK II NAVIGATION SYSTEM

The Mark II Navigation system became available as factory installed optional equipment for all E38/E39 vehicles starting with 9/97 production. Manufactured by Phillips, the Mark II system is the second generation Navigation system based on the Mark I system introduced in October 1996.

To the operator, the Mark II system changes are almost transparent. The overall system function and most of the systems components carry over from the Mark I system.

The Mark II system provides:

- Reduction in the total number of components,
- Simplified control module interface,
- Automatic calibration procedure.

### COMPONENT LOCATIONS AND CHANGES

**Trunk area:** At first glance, the reduction of Board Monitor/Navigation system components in the left side trunk area, is immediately recognized.

- Though the Navigation Computer looks the same as the Mk-1 from it's installed position, it is actually a different component. It provides expanded capabilities and simplified system interface compared with the same component of the Mark I system.
- The GPS receiver module is also a different component. It has an ELO connector for 26 pin breakout box compatibility.
- The radio and audio system amplifier are the same components of the previous system.
- The Video Module of the Mark I system is not utilized with the Mark II system in the US market.

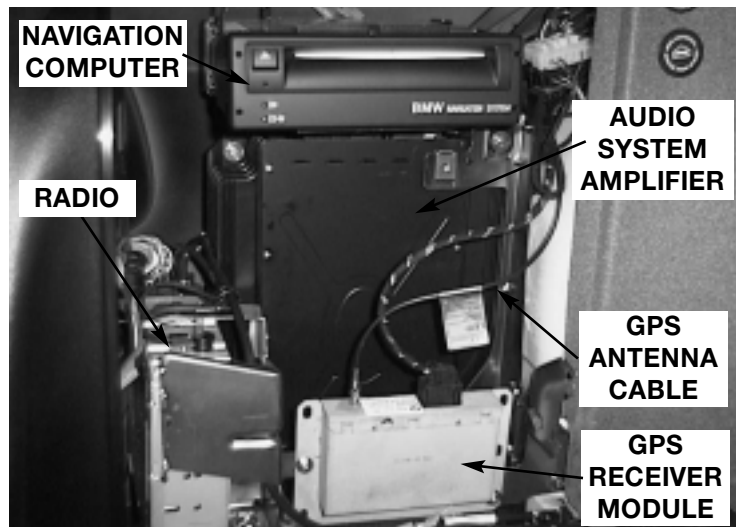

***All of the Navigation system/Board monitor functions previously handled by the video module are controlled by the Mk-2 navigation computer.***

### Parcel Shelf Mounted Components:

The GPS Receiver Module Antenna is the only component of the Mark II system mounted on the parcel shelf.

The antenna component has a slightly different appearance but provides the same function of the Mark I system antenna.

The parcel shelf mounted Magnetic Field Sensor of the Mark I system is not used for the Mark II system.

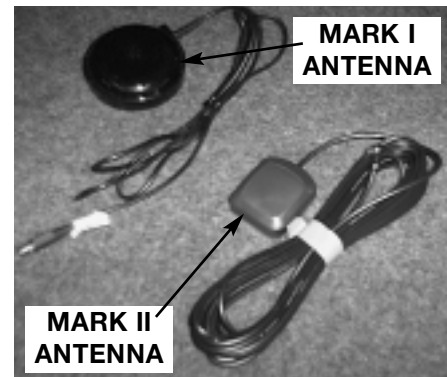

### Board Monitor:

The physical characteristics of the Board Monitor are unchanged from the Mark I system. It provides the visual display information and control for:

- Audio system (radio, tape, cd and DSP systems)
- Board Computer V
- Mark II Navigation system
- Telephone (if equipped)
- Emergency function (Mayday programming)
- Owner customized Board Monitor settings

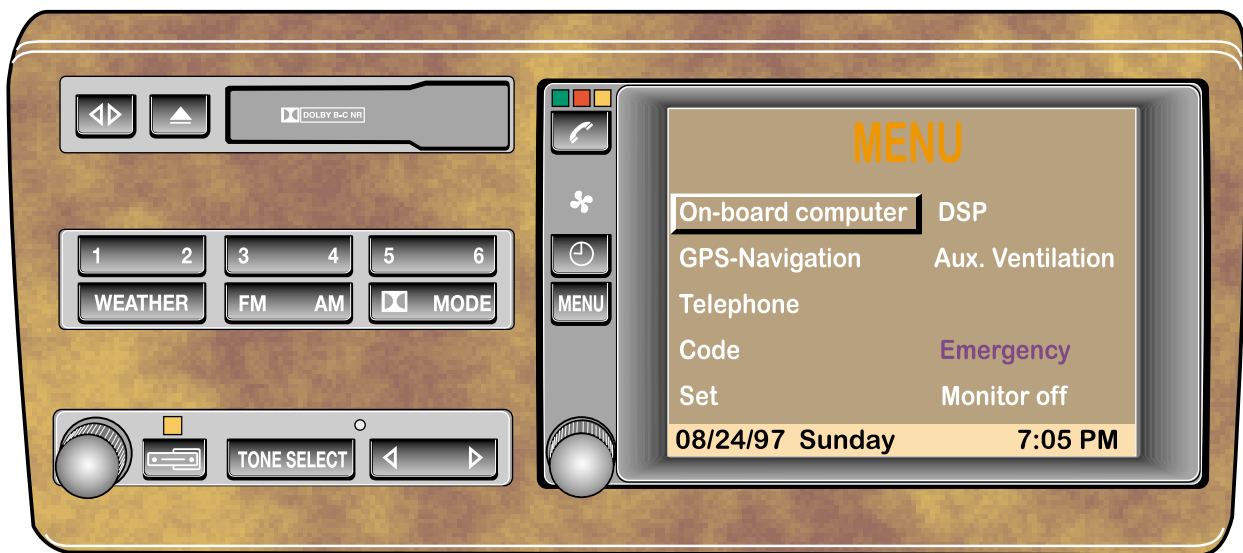

Since the limited television audio capabilities of the Mark I system are not available with the Mark II system, the Television function has been removed from the Board Monitor main menu.

## MARK II NAVIGATION COMPUTER

Though the front bezel is identical to Nav computer of Mark I system, the Mark II Navigation computer is an different new component.

Standardized ELO connectors replace the “blade type” connectors of the Mark I system. This ensures circuit integrity and allows simplified 26 pin breakout box connection for diagnostic purposes.

The expanded capabilities of the Mark II Nav computer has made it possible to delete the following required connectors of the Mark I system:

- the magnetic field sensor input connector,
- the ARCNET triaxial connector,
- the 3 amp fuse has also been deleted.

## INTEGRAL ELECTRONIC PIEZO GYRO SENSOR

The nav computer contains an electronic gyro sensor that detects changes in the vehicle's driven direction (changes in vehicle yaw). Similar to the Rotation Rate Sensor of the DSC III system, the gyro sensor measures the motion of the vehicle on it's vertical axis.

This is an internal component of the Nav Computer. It is not serviceable nor does it require calibration.

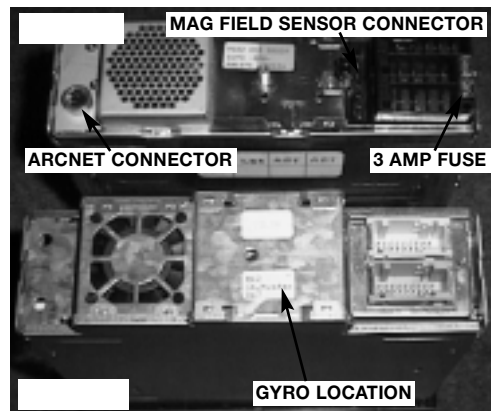
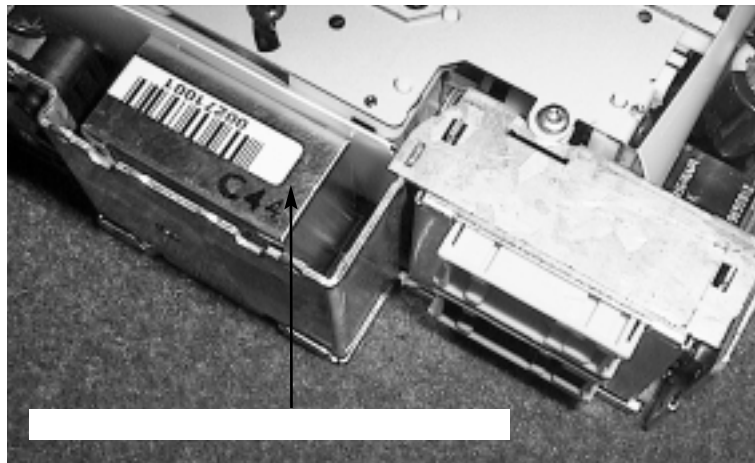

***Do not open the Nav computer, this will void it's warranty. Photo is only intended to provide functional understanding***

The gyro sensor provides status of vehicle turning maneuvers in the form of a changing voltage signal that the Nav computer uses as an input signal.

The Nav computer requires the gyro sensor's input signal along with the digitized map CD, the vehicle speed signal, and the GPS signals together to calculate, continually update and display the exact vehicle position on the LCD.



## Gyro Sensor Operation:

- The internal control electronics of the sensor maintain a constant set frequency which is applied to the oscillation elements causing a calculated vibration to occur. The frequency is also simultaneously monitored by the phase detector.
- The vibration passes up to the pick-up elements of the tuning fork causing them to vibrate and be suspended in a free floating state, easily influenced by rotational movement.

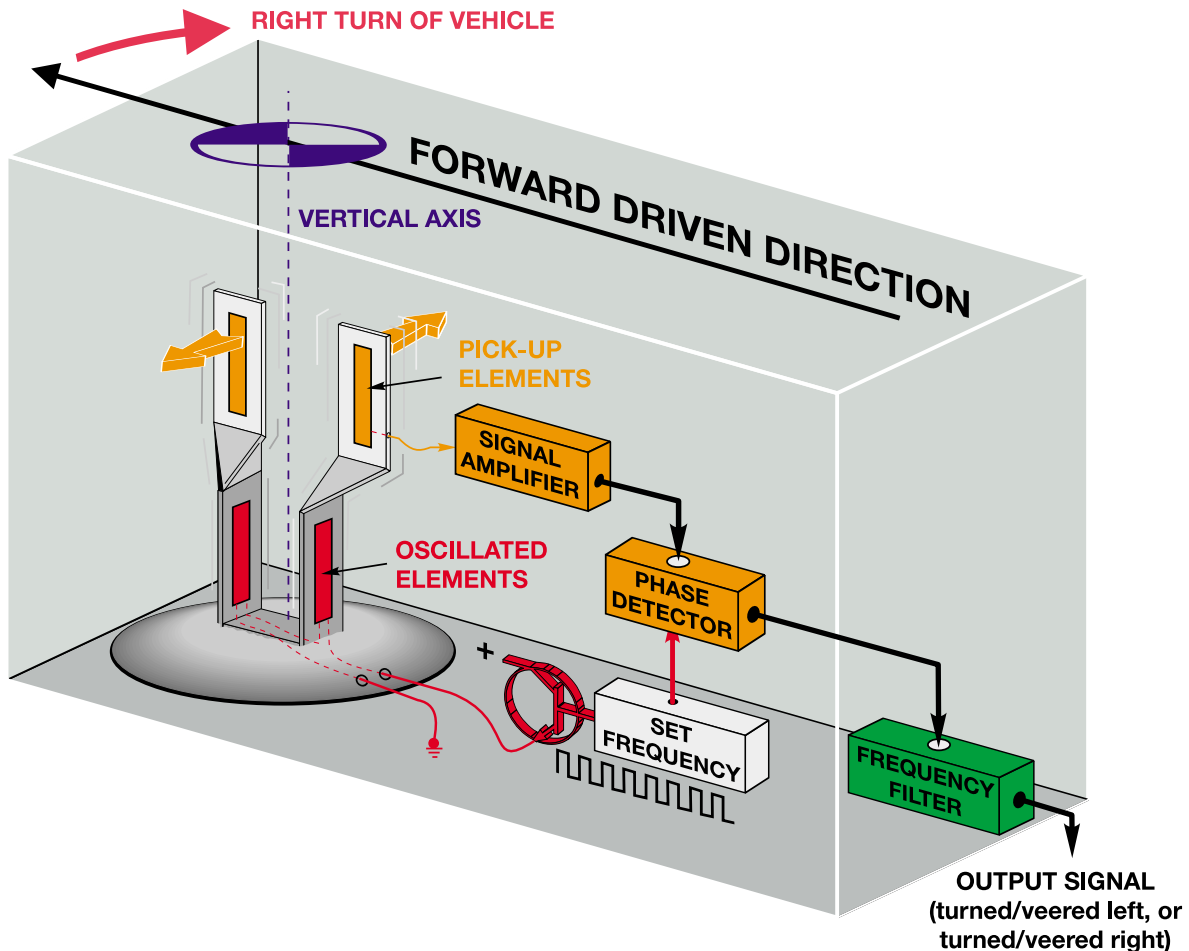

- When the vehicle turns, the free-floating upper ends of the tuning fork flex. This generates a millivoltage signal proportional to the turn.
- The signal amplifier receives the signal and passes it on to the phase detector which compares it to the original set frequency.
- The phase detector determines what direction the vehicle has turned and passes the result on to the frequency filter.
- Since the piezo gyro sensor is also picking up other vibrational movements in the vehicle, the frequency filter isolates the pertinent yaw signals and provides a DC voltage signal proportional to the left/right turning movement of the vehicle.

## ON-BOARD MONITOR AND NAVIGATION SYSTEM INTERFACE

- The I-Bus is the main communication link.
- The video module of the Mark I system is not used with the Mark II system in the US market (reduced cost, simplified system, faster operation).
- The Mark II nav computer communicates directly on the I-Bus (ARCNET not used). It generates the RGB video signals and sends them to the On-Board Monitor LCD. It also provides improved quality audio signals directly to the amplifier for navigation specific audio instructions (“right turn ahead”).
- The Mark II nav computer receives two wheel speed sensor signals from the DSC system for monitoring vehicle speed and distance covered.
- The Mark II nav computer incorporates an electronic gyro compass which takes the place of the magnetic field sensor of the previous system.

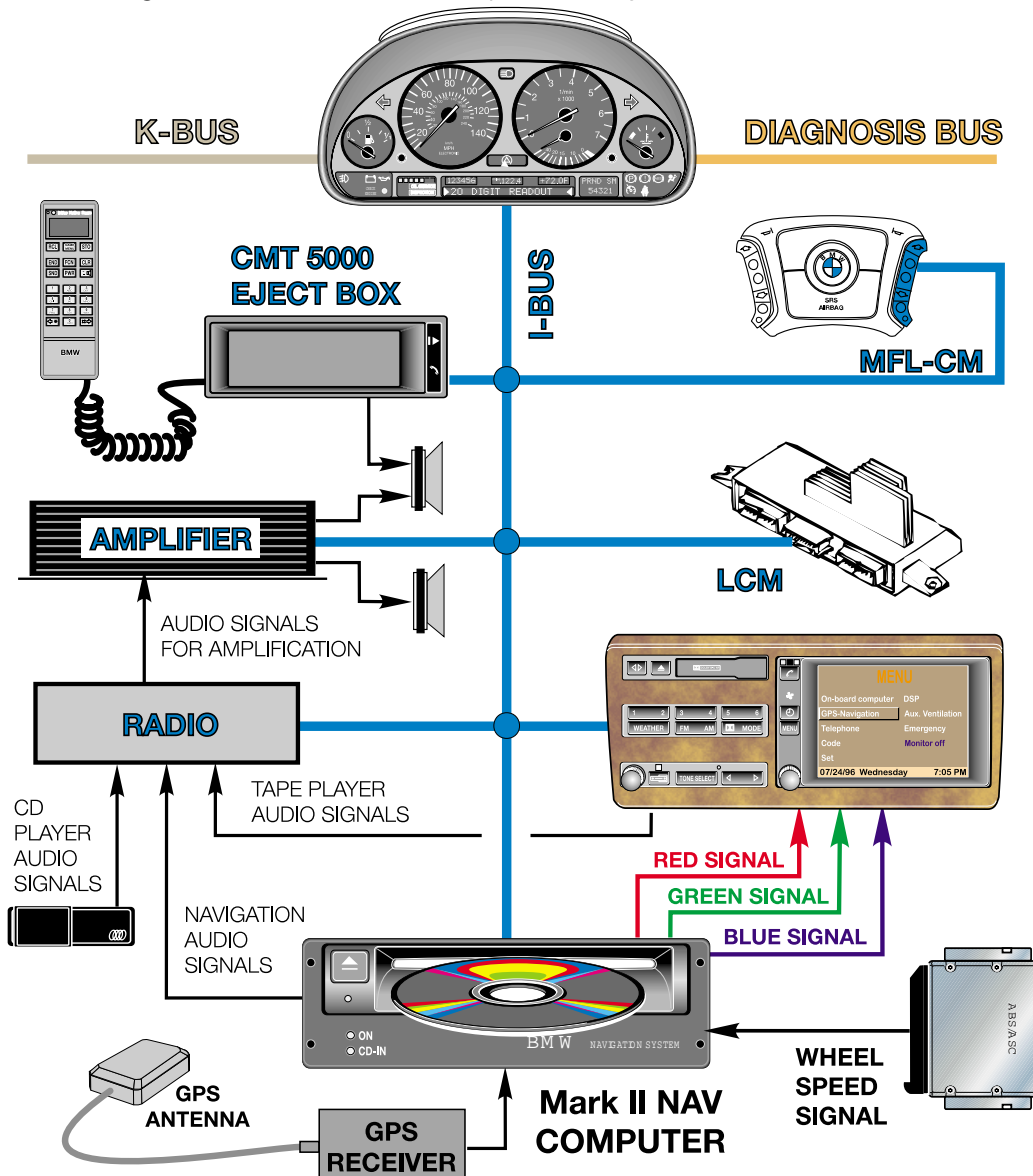

## CHANGES TO THE BOARD MONITOR BASIC FUNCTIONS

At first glance the system looks and operates similar to the previous Mk-1 system. Only when looking further into the control settings and features is a change noticed.

### Automatic Date/Time display:

When a door is opened the GM signals status of “door open” on the K bus. Via the I Bus, the IKE passes the signal onto the Nav computer which generates the RGB signals for display of the Date/Time on the bottom edge of the LCD.

The **Set** function of the opening menu provides additional owner customized settings for the board monitor display.

After selecting set from the main menu, scroll down to the bottom of the list, an additional three items are included:

- **BC display:** Provides selection of either the **outside temperature** or estimated **arrival time** of the set distance set in the board computer functions. These items are displayed along with the other BC functions when the Audio + BC is set function is “On”.
- **Color set:** Provides three set variations of screen color schemes.
- **Day/night:** Provides a deviation of the selected color set when the headlights are switched on.

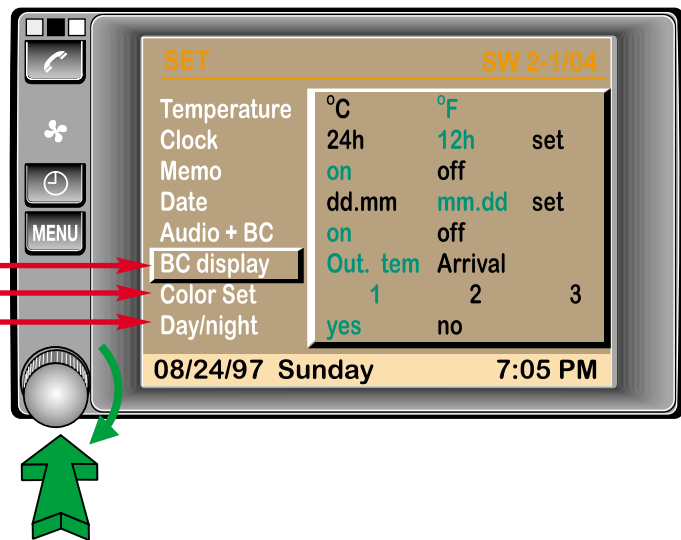
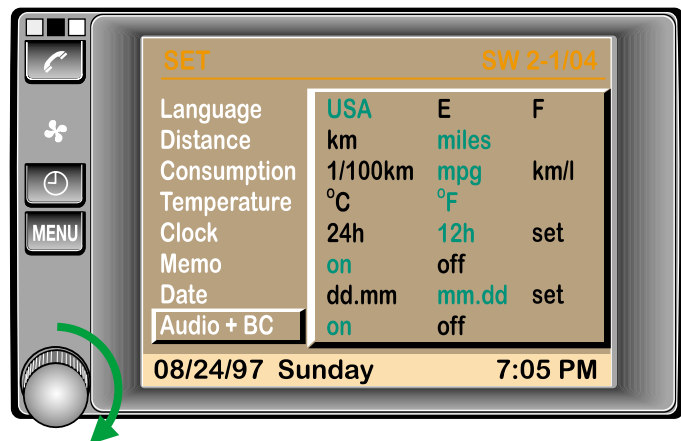
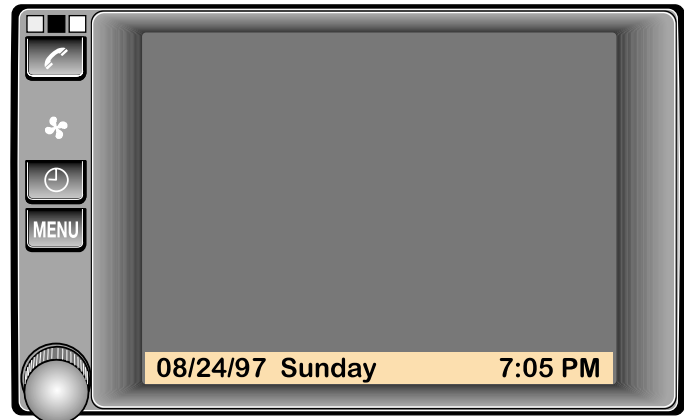

Though subtle, these changes provide added convenience and provide the owner the opportunity to slightly customize their vehicle's On-board monitor display.

## NAVIGATION SYSTEM DIAGNOSTIC MODE DISPLAYS

The Mark II system does not communicate with the DIS. It does however provide an onboard diagnostic mode on screen display function.

These screens provide system hardware/software identification numbers and status of Navigation specific functions for use as a diagnostic tool. The screens are accessed as follows:

- From the main menu select "Set".
- Once in the Set function, press and hold the menu button for 8 seconds.
- The first screen to appear is the SERVICE MODE menu.

The On-board monitor and Video module selections are not functional even though they are displayed.

The first accessible function is the NAVI/GRAPHIC ELEMENT. This screen is for identification of hardware/ software specific index versions for the installed system.

The next available selection from the service mode menu is GPS. Pressing GPS brings up the GPS version display.

This display provides the GPS receiver module hardware version number and date of programmed software.

Pressing the functions button in the lower right corner of this screen provides a sub-selection menu of additional GPS system status.

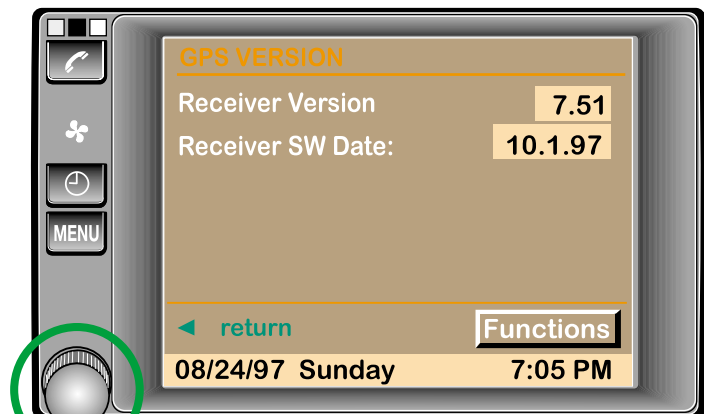
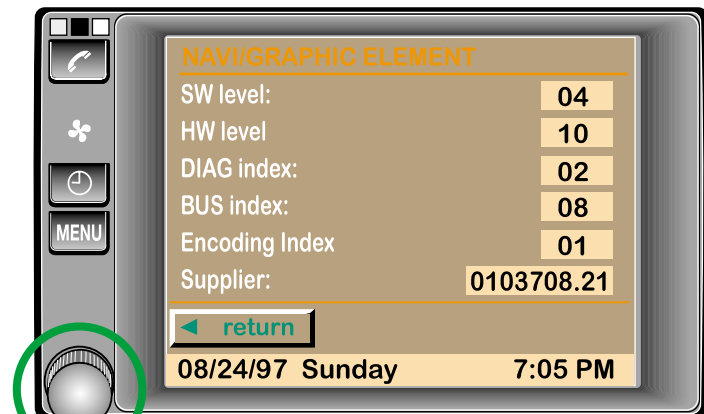
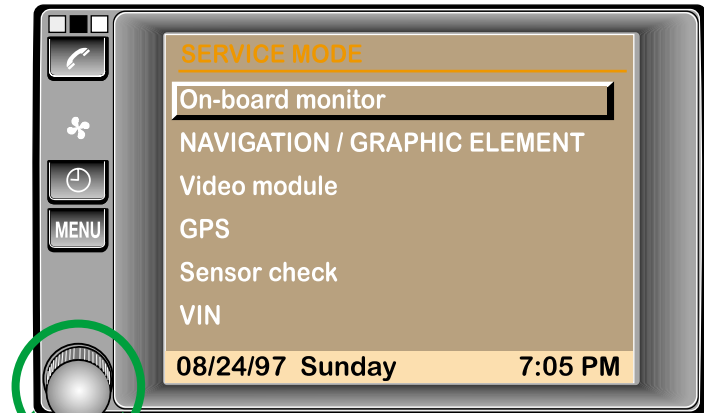

The sub-selection menu additionally includes GPS “Status” and “Tracking” choices.

- GPS Status provides information on the exact coordinates of the vehicle based on the calculations of the GPS receiver module.
- GPS Tracking provides information about the individual satellites currently sending signals to the GPS receiver module.

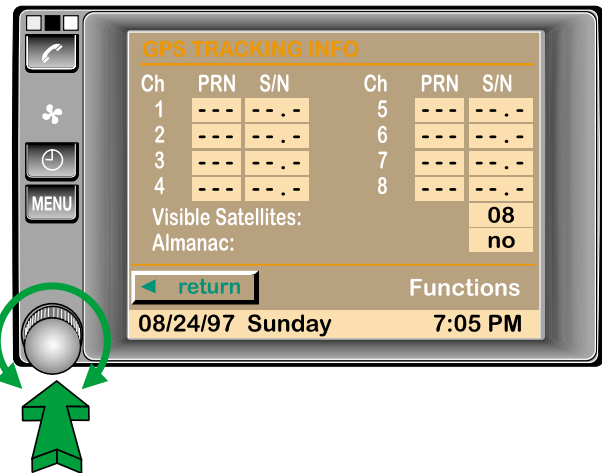
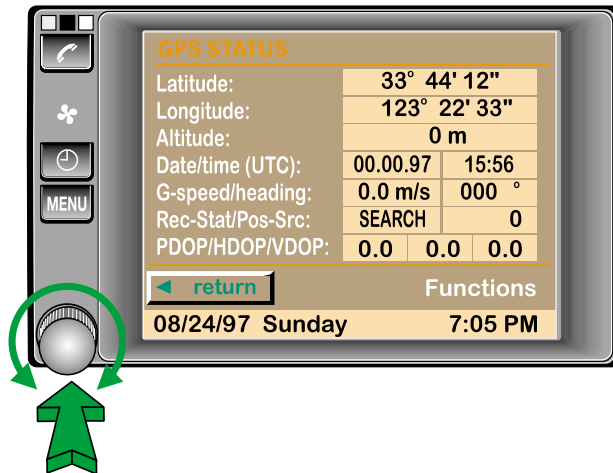
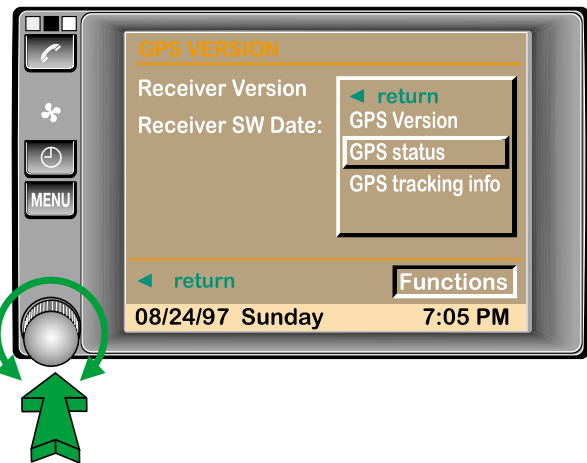

The next selection available from the SERVICE MODE menu is “Sensor check” which provides:

- Wheel speed input (only one wheel speed signal, displayed in the right side window),
- Total number of GPS satellites currently providing signals,
- What mode the GPS receiver module is currently in; (ie: Search)
- The Gyro status provides the millivoltage value the Nav computer is utilizing for the current vehicle position. This area also includes an icon representing what direction the vehicle is heading in.
- The direction status relates to what gear the vehicle is currently in (forward or reverse).

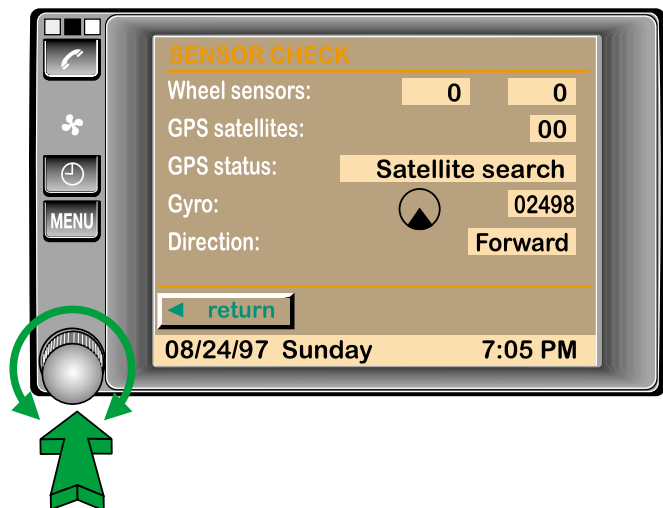

The last selection available in the Service Mode menu is the **VIN** entry display. The VIN is entered at the VPC when prepped prior to distribution. This is for the VIN display in the Emergency program if needed when calling the Cross Country Group Roadside Assistance Program. Additionally, if the vehicle is equipped with a Phase V phone the system will automatically utilize the entered VIN as follows.

Similar to the previous phone system, the Phase V phone has the capability to contact Cross Country Group using the “Assist” or “Emergency” button from the Emergency or Telephone functions.

What’s new for the Phase V system is the use of dual tone multi frequency (DTMF) signalling.

DTMF signalling provides a download of the VIN, the telephone number of the Phase V phone and the vehicle coordinates when the assist button was pressed. This information is displayed on a computer screen of the Cross Country Group “assist” personnel prior to any verbal communication taking place.

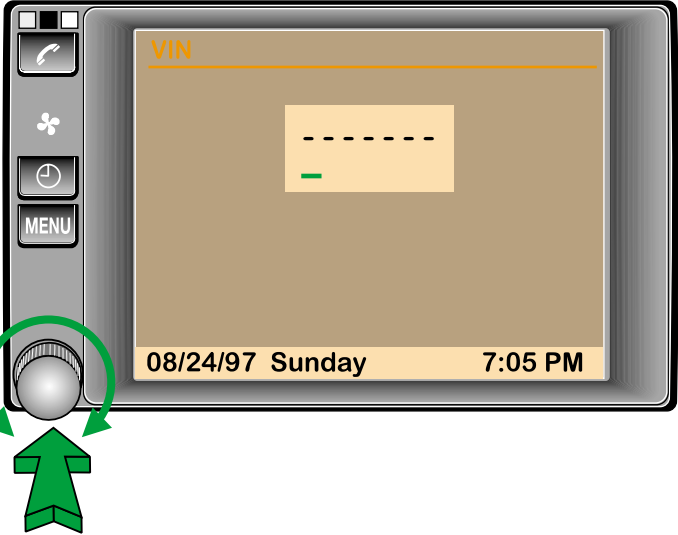

Through a data base, the VIN provides the Owner’s Name. This, in conjunction with the vehicle coordinates and the phone number provides the “assist” personnel with crucial preliminary information.

When the call is patched in from the vehicle, the assist personnel can answer appropriately for an “assist” or “emergency” situation. This quick response with the owner’s pertinent information provides an added personnel touch and time savings in an emergency situation.

The VIN is entered at the VPC for all vehicles (with or without a Phase V phone). If the VIN has been incorrectly entered it can be changed by turning and pressing the rotary knob when the correct letter or digit of the last seven character of the VIN is displayed.

---

---

---

---

---

---

---

## MARK II NAVIGATION SYSTEM CALIBRATION

The calibration procedure of the Mark I system is not required with the Mark II system. This system self calibrates automatically as the vehicle is driven after following the steps below.

- System must be fully functional with no faults present in fault memory.
- Correct Map data base CD installed for your area.
- Vehicle outside with an unobstructed overhead view. Switch ignition on and allow system adequate time to receive a minimum of three GPS signals. This is confirmed by the green GPS indicator in the map display.
- Set the map display to the 400' scale and drive the vehicle on digitized roads. Make frequent turns at intersections where possible.

While driving, the system utilizes the map CD, the received GPS coordinates, the Gyro sensor to determine turn activity and the wheel speed sensor input. It compares all of these variables and automatically pinpoints the vehicle position.

## MARK II NAVIGATION SYSTEM DIAGNOSIS

The reduction of Nav system components also reduces the scope of diagnosis. The Nav computer and Board monitor are the systems which must be considered for when diagnosing the total system.

The Mark II Navigation computer does not communicate with the DIS tester. Use the onboard diagnostic screens outlined on the previous pages for navigation system specific diagnosis.

Follow the fault symptom path of the DIS Diagnosis Program for detailed diagnostic procedures for the board monitor and LCD panel.

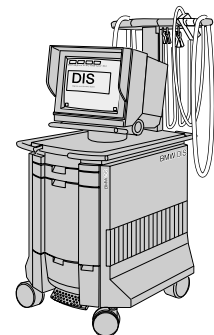

---

## **Mk-3 NAVIGATION SYSTEM**

**Models: E38, E39, E46, E52, E53**

**Production Date: E46 from 6/00, all others from 9/00**

### **Objectives**

After completing this module you should be able to:

- Recognize the changes to Mk-3 from the previous Mk-2 navigation system.
- Identify the components used in the system.
- Describe how to properly code and program the Mk-3 computer.



---

## **Purpose of the System**

The Mk-3 navigation system is a factory installed navigation system that replaces the previous Mk-2 version. The purpose of the system remains the same as previous navigation systems: To provide the driver with navigation instructions to an entered destination based on the vehicles current position and the roads available selected from a digitized road map.

### **The principle differences of the Mk-3 system over the previous Mk-2 are:**

- GPS receiver is integrated into the MK-3 computer.
- Optimized memory and faster processor resulting in faster start-up and operation.
- New split screen and magnifying feature when equipped with wide screen monitor. (software feature)
- Same navigation computer used for color board monitor or monochrome MIR display units.

## System Components

### Mk-3 Navigation Computer

The Mk-3 navigation computer is located in the left side of the vehicles trunk or cargo area. (In the case of the Z8 it is installed in the storage box behind the passenger seat.)

The navigation computer housing contains:

- Map CD drive
- Hardware for navigation function
- GPS receiver
- Gyro sensor
- Output for audio interface
- Output for visual display
- Cooling fan for unit



There are two different hardware versions available dependent on the angle of installation in the vehicle (horizontal or vertical). The Mk-3 is compatible with both board monitor or MIR display units. **(See workshop hints for configuration instructions)**

Identification of the Mk-3 computer over the previous versions is easy due to a change in the face plate design and the elimination of the “CD-IN” LED.

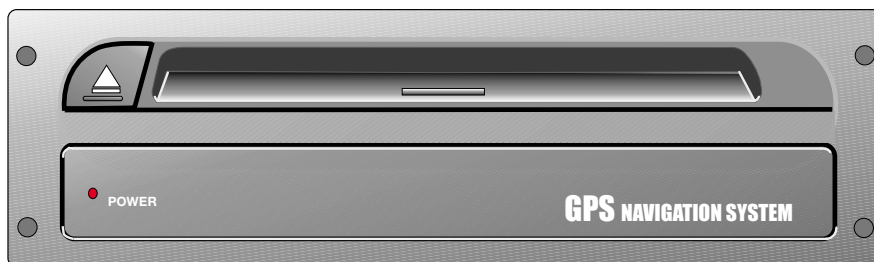

**Mk-3 Navigation Computer**

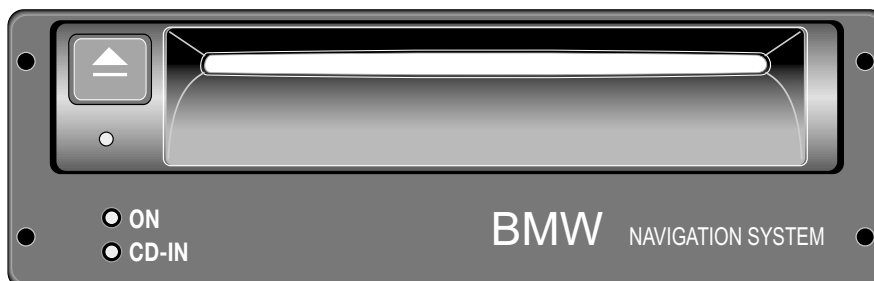

**Mk-1 and Mk-2 Navigation Computer**

## Mk-3 computer

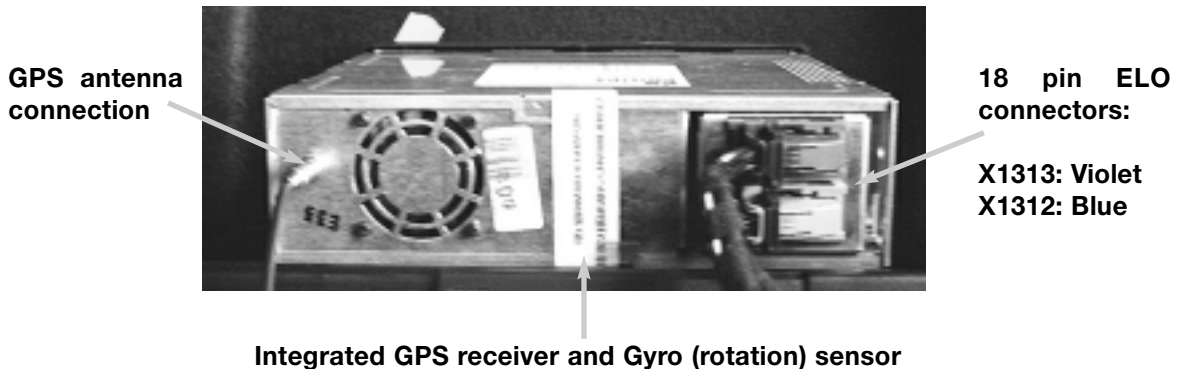

### GPS (Global Positioning System) Receiver

The GPS receiver module of the previous Mk-2 system is integrated into the housing of the Mk-3 computer, further reducing the complexity and the number of components used in the system. The receiver is not serviceable.

The GPS receiver is responsible for receiving the satellite signals and providing the vehicle's position information to the navigation computer.

Information provided by the GPS receiver to the navigation computer can be displayed in the service mode (**see workshop hints**) but is not typically used in diagnosis.

### Gyro (Rotation) Sensor

The navigation computer contains the electronic (piezo) Gyro sensor that detects rotation (yaw) of the vehicle as a confirmation that the vehicle is turning. The signal provided by the gyro is a milli-voltage that changes as the vehicle rotates. The navigation computer uses the input to track the vehicle along the digitized map and display the exact vehicle position.

The signal is available in the sensor test page of the service mode for diagnosis. The sensor is not a separately serviceable item and does not require calibration.

## GPS Antenna

The GPS antenna is directly connected to the navigation computer via a coaxial cable. Locations of the antenna in the vehicles are as follows:

<b>E38:</b>	<b>Under the rear parcel shelf.</b>
<b>E39 sedan:</b>	<b>Under the rear parcel shelf.</b>
<b>E39 Sport Wagon:</b>	<b>Behind the dashboard on the left side.</b>
<b>E46 sedan/coupe:</b>	<b>Under the rear parcel shelf.</b>
<b>E46 Sport Wagon:</b>	<b>Above the rear glass under the spoiler.</b>
<b>E46 Convertible:</b>	<b>Behind the instrument cluster.</b>
<b>E52:</b>	<b>Left front corner behind the dashboard.</b>
<b>E53:</b>	<b>Above the rear glass under the spoiler.</b>

## Display Units

Based on the particular model, the factory installed Mk-3 system is displayed using a color board monitor or on a smaller monochromatic screen (MIR).

### E52 MIR (Multi Information Radio)

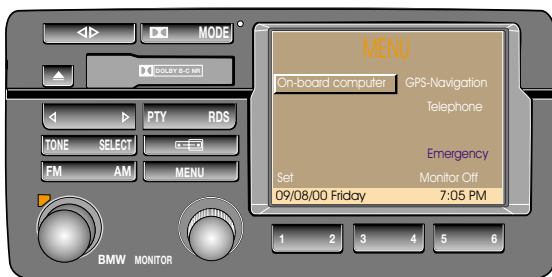

### E46/E53 Color Board Monitor

### E38/E39 Wide Screen Color Board Monitor (phased in for E53 1/01, E46 9/01)

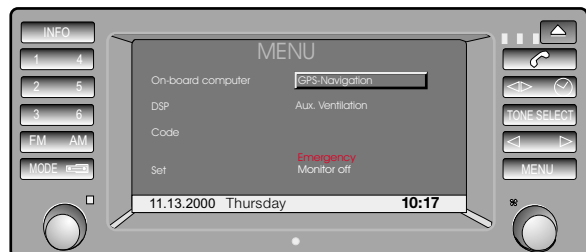

# Navigation System Interface

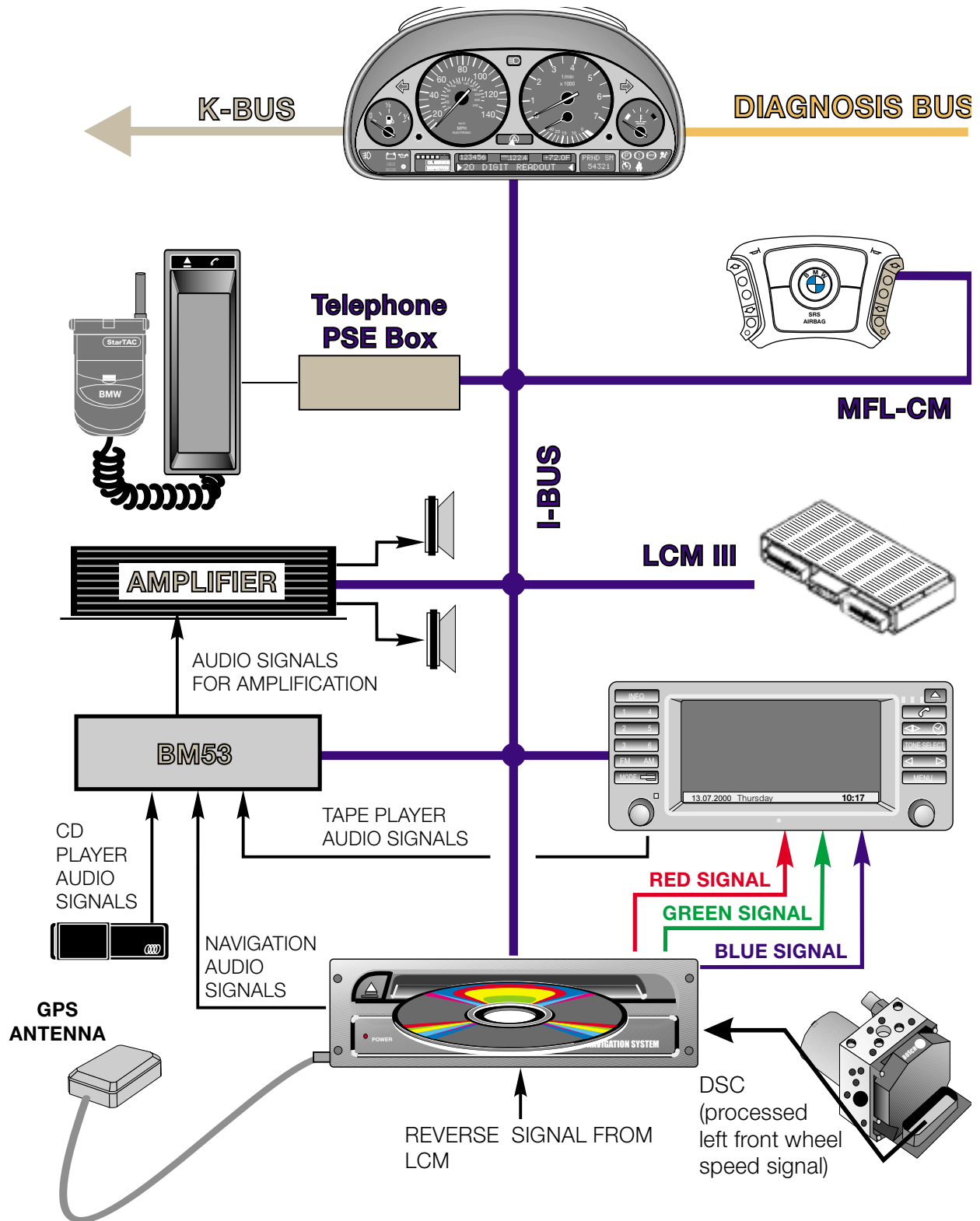

Example of E38/E39 with Mk-3 navigation

## Information/body bus Interface

The navigation computer is integrated into the vehicle bus system as it's main communication link with the vehicle.

Communication occurs with the following modules:

- **BMBT** - Control inputs
- **Radio** - Display data
- **GM** - Door open
- **IKE/Kombi** - On-board computer data
- **Telephone PSE Box** - Monitor display data, mayday function
- **DISplus** - Coding data

**PSE = Portable Support Electronics**

## Video/Audio Signals

### Board Monitor (Top Navigation)

The RGB video signal for all display functions of the board monitor are produced by the navigation computer graphics stage via three output signals. The Red-Green-Blue signals are direct inputs to the board monitor. The audio signals for navigation instructions to the radio are sent via two separate lines.

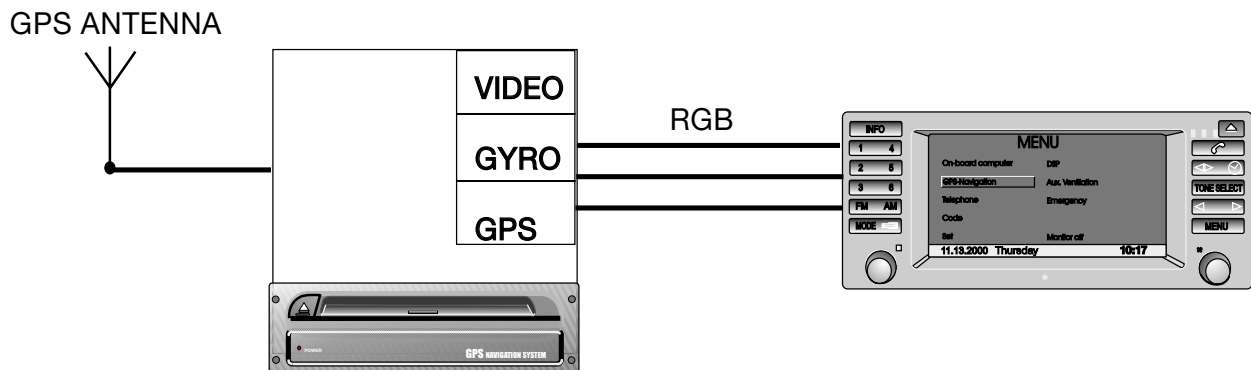

### MIR (Radio Navigation)

Since a color display is not used for the MIR, the navigation information for the display is sent via a NAV bus. The NAV bus is a single dedicated line between the Mk-3 computer and the MIR. Audio signals for navigation instructions are sent to the radio via two separate lines.

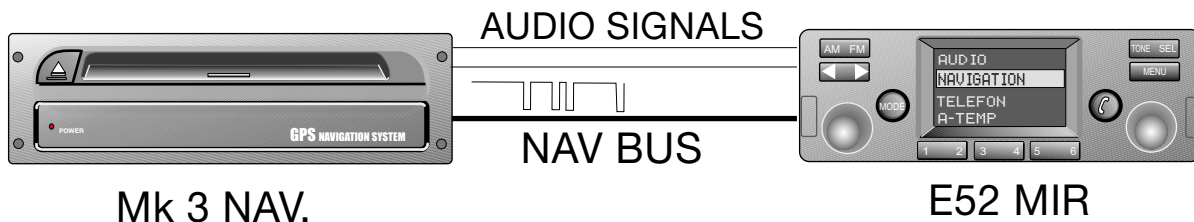

## Speed Signals

A speed signal is provided to the navigation computer for detection of distance traveled and vehicle speed to calculate the vehicles position on the digital map. The input is a processed signal provided by the vehicles DSC control unit.

- E46: The speed signal used is from the **left rear** wheel.
- E38/E39/E52/E53: The speed signal used is from the **left front** wheel.

## Reverse Gear Input

The reverse gear input is used by the navigation computer to distinguish between the vehicle backing up or turning around.

- E38/E39/E52/E53: The reverse input is a high signal produced by the LCM III.

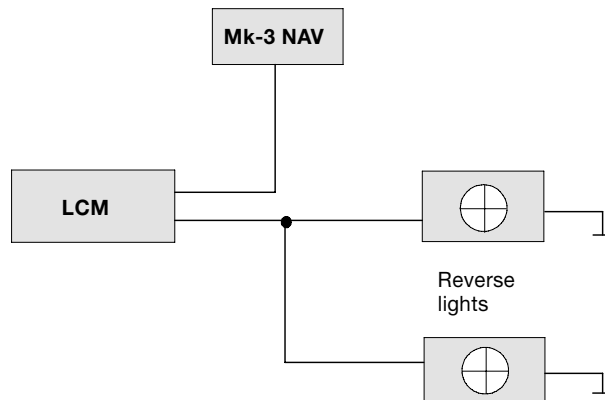

- E46: The reverse input is a high signal supplied by a splice from the back-up lights.

### Automatic Transmission version shown

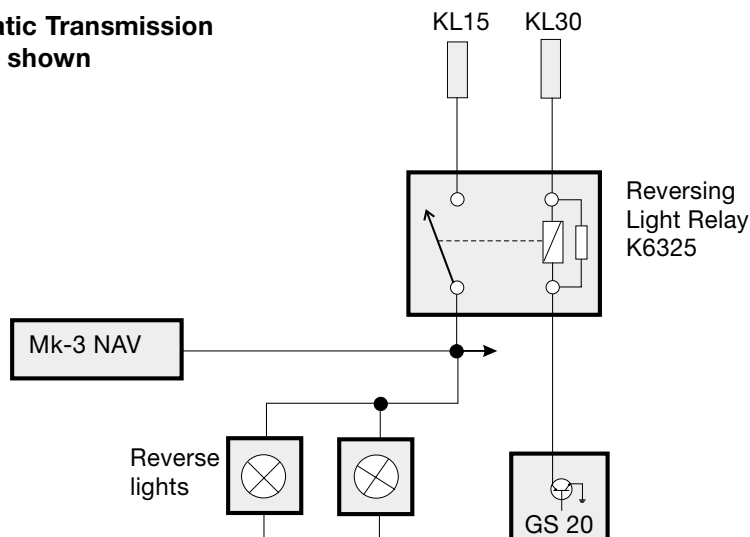

## Workshop Hints

### Replacing the Mk-3 navigation computer

When replacing the Mk-3 navigation computer be aware that there are two hardware variants depending on the installation position (vertical or horizontal).

The ignition should be in position 0 during removal and replacement of the computer. After installing, close all doors, hood and trunk. A bus line reset will be carried out within two minutes. Resetting allows the gyro to perform a calibration run. Do not move the car during this reset period.

The coding sequence for the Mk-3 navigation computer has been changed from the previous Mk-2. There is now an additional step (configuration) that must be done before the software can be loaded.

After resetting, a configuration signal is needed to allow the computer to load the correct software for use with a board monitor or MIR. This is performed using the DIS coding program (CD 22.0 onward) and the Navigation System operating software (CD V15.0 onward).

**Note: Vehicles using the wide screen BM require CD V16.1 onward.**

1. From the DIS/MoDiC Coding /Programming select "1 ZCS Coding"
2. Select the appropriate series (E46,E39,E38,E52,E53)
3. Select "4 Conversion"
4. Select "3 IKE?Kombi"
5. Select "2 language"
6. At the prompt "is the CD ROM present?" select yes , but do not install the operating software CD ROM yet.
7. First select the main language and then an additional language. (i.e. English-spanish)
8. Select the gender of the navigation audio voice.
9. Select "automatic coding-yes"

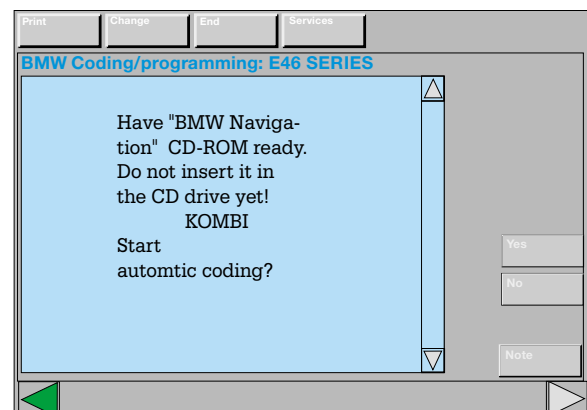
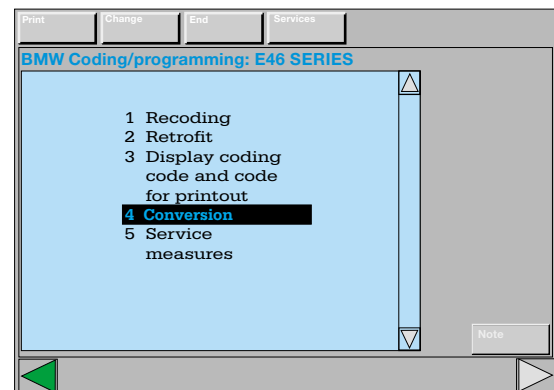



10. After coding is done the DIS/MoDiC instructs you to follow the instructions on the monitor for the installation of the Navigation System CD ROM.

11. Place the navigation system software in the navigation computer CD drive.

**Important:** Do not switch the ignition off during the software loading procedure. Do not use any software for the Mk-3 earlier than CD V15.0.

12. Once loading has been completed, remove the CD and then confirm completion by pressing the rotary push-button on the monitor.

13. Turn off the key for 10 seconds, then turn it back on and conduct a functional check.

14. After this step has been finished, encode the navigation computer using the “Recoding” path in ZCS Coding. The coding process involves coding vehicle specific data: VIN, Model, Telematics data etc.

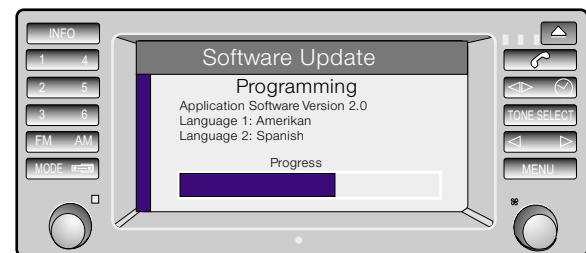
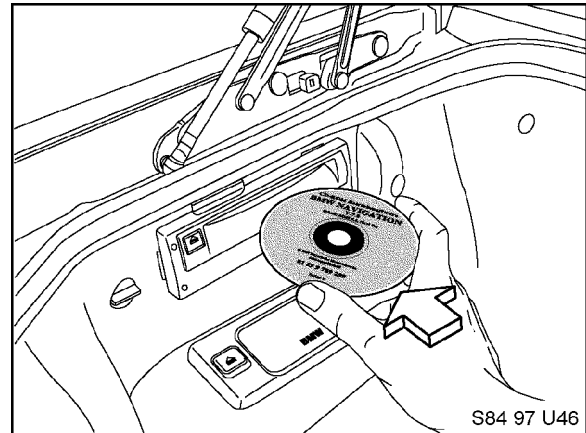

The software status can be confirmed from the “Set” screen for Mk-3 systems.

- **3** = Third generation system Mk-3.
- **1** = Device variant (1=Color screen, 2= MIR monochrome screen).
- **20** = Software version of the graphic component (Version 2.0).

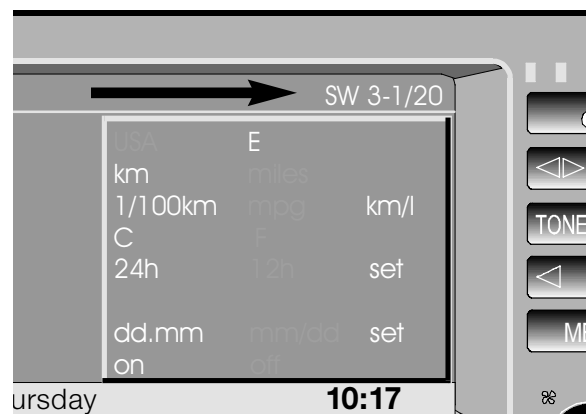

After the navigation computer has been successfully programmed and coded the vehicle should be left in an area with a clear view of the sky with the key in KL R for at least 15 minutes to complete the calibration process.

## Service Mode

Just as Mk-2, Mk-3 provides an on-screen service mode for diagnosis. The service mode provides five different test screens:

- On-board monitor
- Navigation/Graphic element
- GPS
- Sensor Check
- Telematics

### To enter the Navigation Service Mode:

- Turn the ignition key to position 1 (KL R).
- From the Menu screen select “SET”.
- Once in the Set screen, press and hold the “MENU” button for 8 seconds.
- The Service Mode menu will appear on the display.
- Select from the Service Mode menu for navigation specific tests.

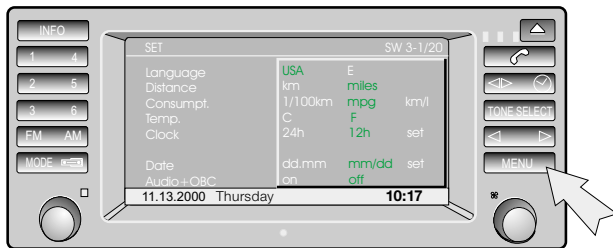

Press and hold for 8 seconds after entering the “Set” mode

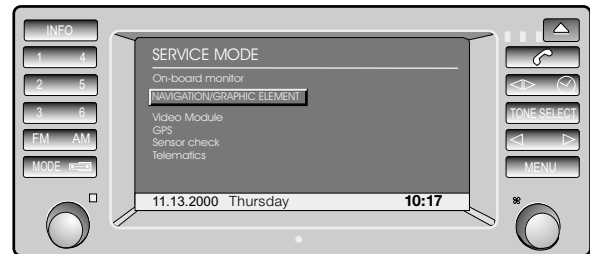

Service Mode main menu display

## Diagnosis

Diagnosis is carried out using Test Modules in the Diagnosis Program as well as on-screen in the Service mode. The Sensor Check display is intended to be used while test driving the vehicle. The following pages contain charts with explanations of the Service Mode display.

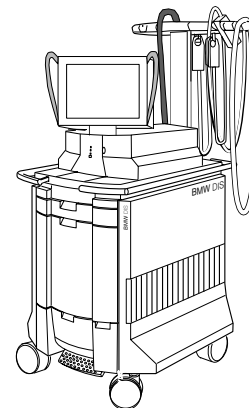
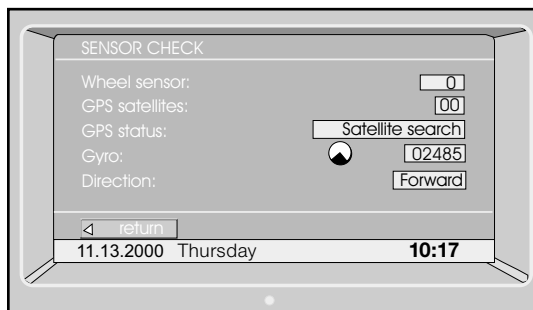

<b>STATUS DISPLAY</b>	<b>WHAT SHOULD BE DISPLAYED</b>	<b>WHAT TO DO IF NOT OK</b>
<b>Wheel Sensors:</b>	As the vehicle is driven, the number should increase with an increase in vehicle speed.	Check fault codes in DSC system. If necessary carry out wheel speed sensor test.
<b>GPS Satellites:</b>	With unobstructed upward view of sky the display should be > 3	Check for interference of signals to GPS antenna, Check integrity of circuit from GPS antenna to nav computer.
<b>GPS Status:</b>	"See Legend below"	
<b>Gyro:</b>	<p>Direction icon moves with vehicle turning movement.</p> <p>Milli voltage display value should be approx 2500 mV (+/- 400mV) when the vehicle is stationary or driven straight ahead.</p> <p>When the vehicle is turning, the signal voltage should increase on right hand turns and decrease on left hand turns.</p>	Replace Navigation computer.
<b>Direction:</b>	Reverse is displayed when range selector is in reverse. Forward in any other range.	Check back up light signal input.

<b>GPS Status Text Display</b>	<b>Description</b>
1. "GPS fault"	Problem with GPS system. Swap nav computer and or antenna from know good vehicle after checking GPS status display information
2. "Reception Interference"	Problem with GPS system. Same as above.
3. "No Almanac"	No Data yet stored from satellites. The GPS almanac is a memory account of received satellite signals. If the vehicle battery has been disconnected or after replacing a nav computer it has an empty memory and requires satellite signals to become functional. After the nav computer receives battery voltage and ground, it must be left outside with an unobstructed sky above with the ignition switched to KL R for approximatly 15 minutes.
4. "Satellite search"	GPS is currently searching for satellite signals.
5. "Satellite contact"	At least one satellite is found
6. "Position known"	Vehicle's Latitude and Longitude known. Navigation is possible.

<b>Menu</b>	<b>Display</b>	<b>Explanation</b>
GPS/Status	G-speed Heading Rec status Pos-src PDOP HDOP VDOP	Relative speed over the ground Direction of travel Search/track/position receiver status Number of satellites available for analysis Accuracy of the calculated location <8=sufficient determinations of location <4=very good determinations of location
GPS/Tracking info	CH PRN S/N Visible Sat  Almanac	Channel Satellite detection Better reception as the value increases Number of visible satellites, receivable Signals, depending on time of day/configuration Satellite database, loaded automatically after 15 minutes
Telematics	VIN Color GSM BMW info Emergency call out Initialization Logging off	VIN (Automatically assigned during coding) Color code or text Telephone network/contract number Customer specific info On/off status Telematics services on/off status Logging off telematics services

**PDOP**      **Position Dilution of Precision**  
**HDOP**      **Horizontal Dilution of Precision**  
**VDOP**      **Vertical Dilution of Precision**  
**S/N**        **Signal/noise relationship**  
**Gyro**      **Piezo gyro sensor (in navigation computer)**  
**Dir**        **Direction of travel**

---

## Review Questions

1. List the most significant changes made to the Mk-2 navigation computer over the previous Mk-1. Describe the changes between Mk-2 and Mk-3. \_\_\_\_\_  
\_\_\_\_\_  
\_\_\_\_\_
2. How can the signal provided by the gyro sensor to the navigation computer be checked? \_\_\_\_\_  
\_\_\_\_\_
3. Describe how the **display** signals are transmitted from the navigation computer to the MIR and board monitor. \_\_\_\_\_  
\_\_\_\_\_  
\_\_\_\_\_
4. What step is necessary before loading the navigation computer operating software CD on a newly replaced Mk-3 navigation computer? Where can the software status be confirmed after it has been loaded? \_\_\_\_\_  
\_\_\_\_\_  
\_\_\_\_\_
5. How is the VIN entered into the Mk-2 or Mk-3 navigation computer? \_\_\_\_\_  
\_\_\_\_\_
6. Describe the situations that would require a full calibration be performed on a Mk-1 navigation computer. \_\_\_\_\_  
\_\_\_\_\_
7. How are the On-Board Monitor input signals (function requests) received by the Nav. computer, Radio, IKE, IHKA and Telephone? \_\_\_\_\_  
\_\_\_\_\_  
\_\_\_\_\_